

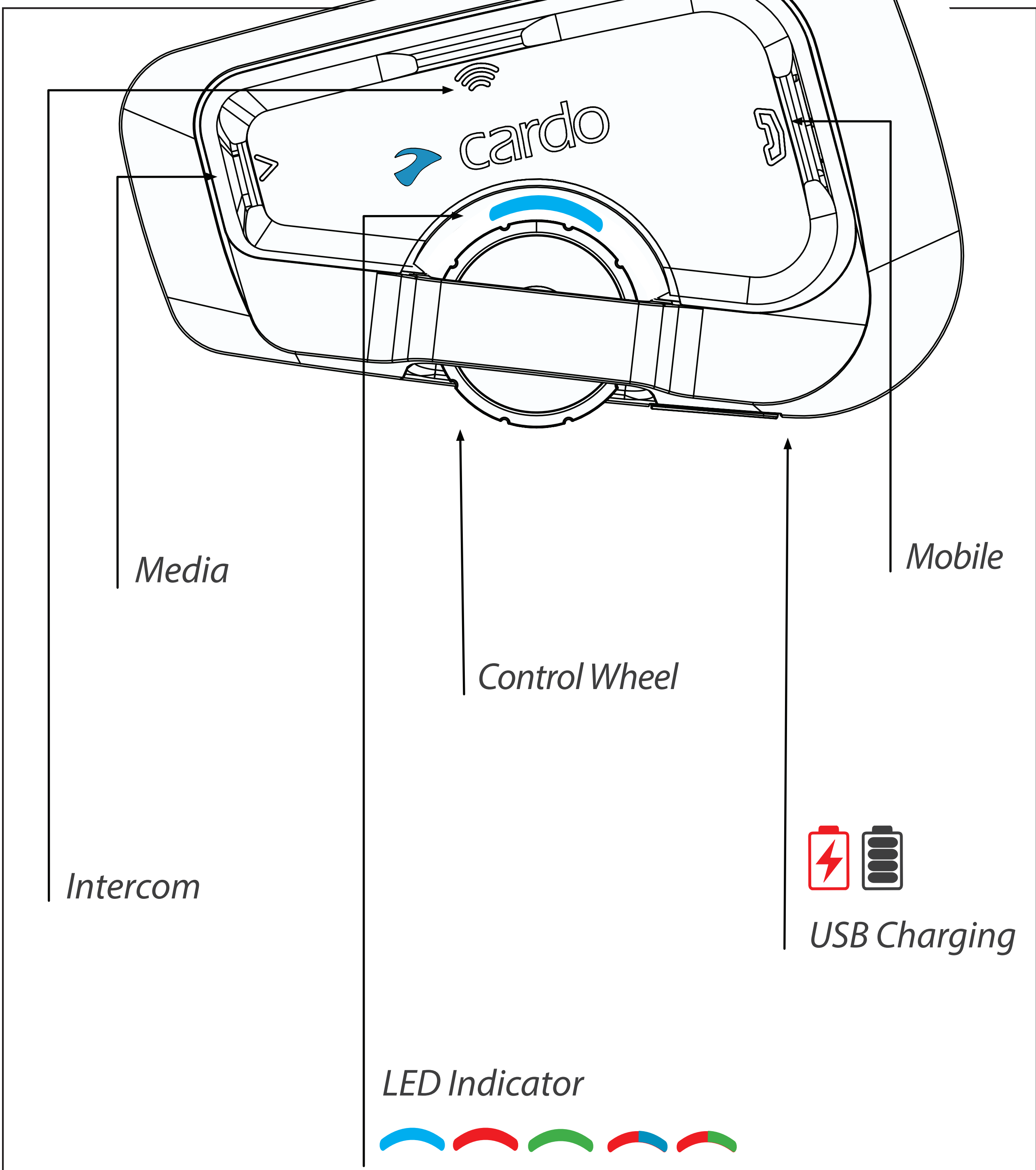

CARDO
FREECOM 4x

.....
POCKET GUIDE

EN



Press & Hold



Number of Taps

Getting Started

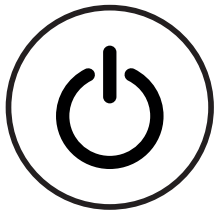

On / Off

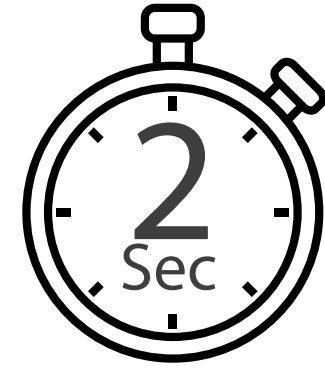
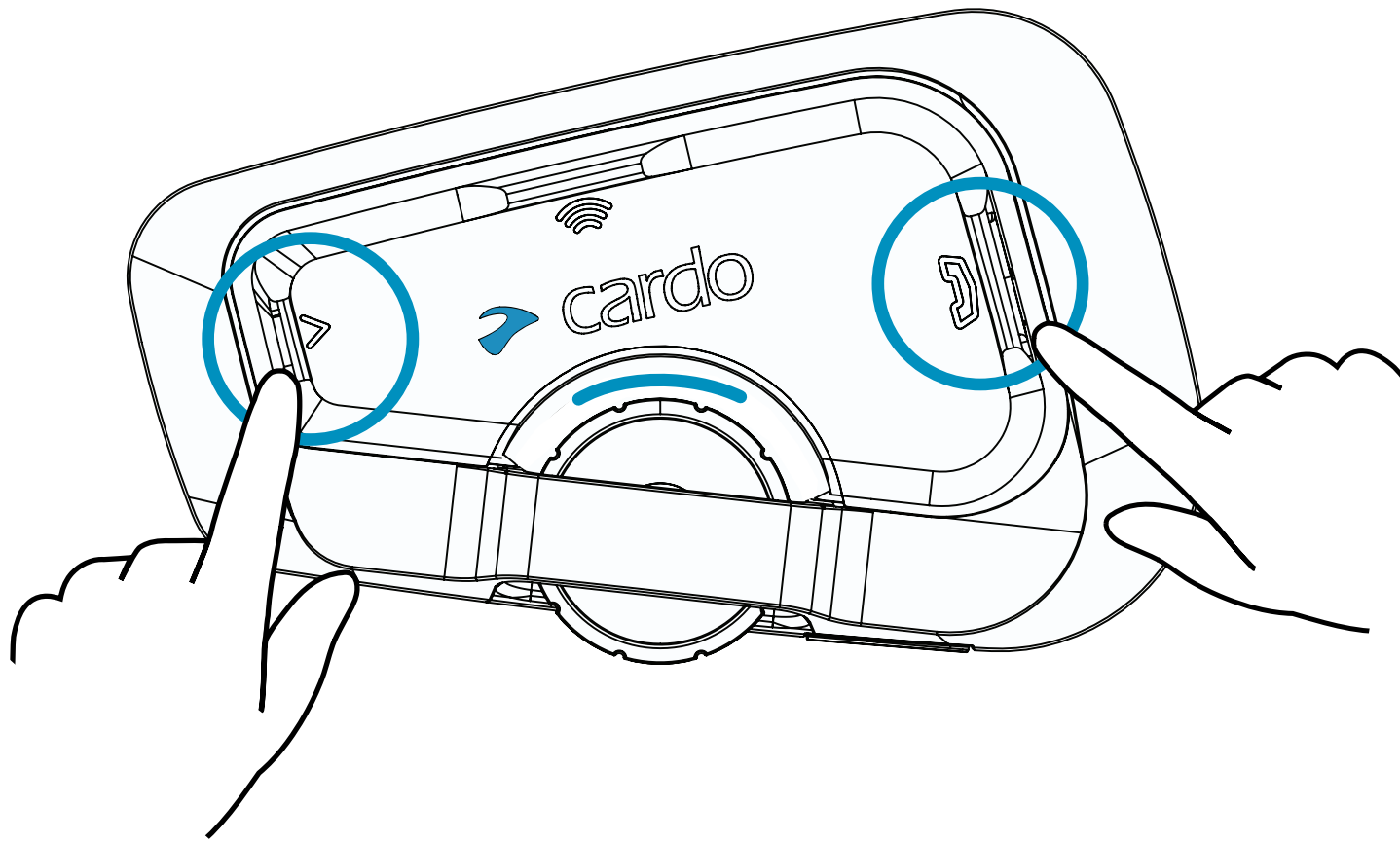

Phone Pairing

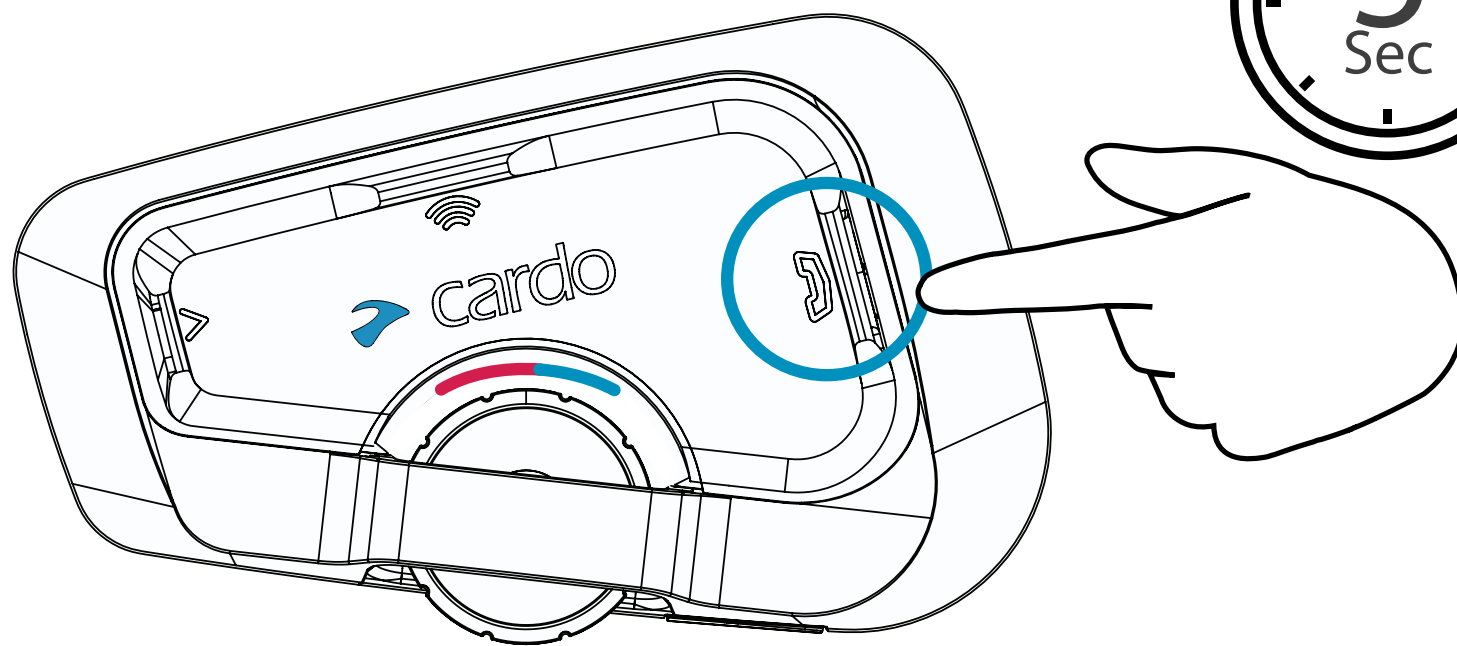

LED Red & Blue 



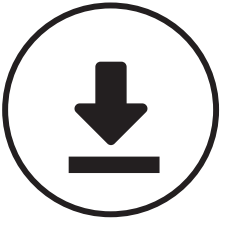

Download



Register

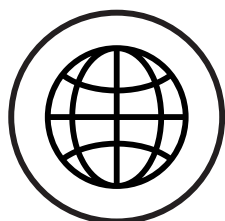
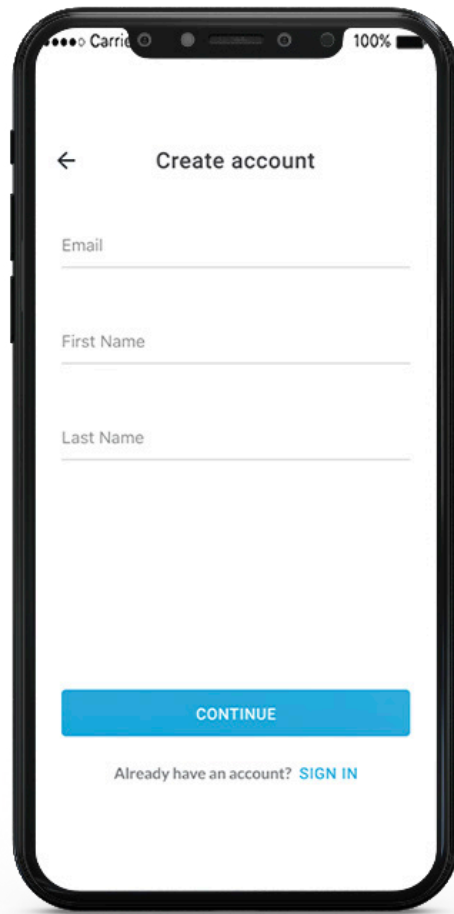

Choose Language

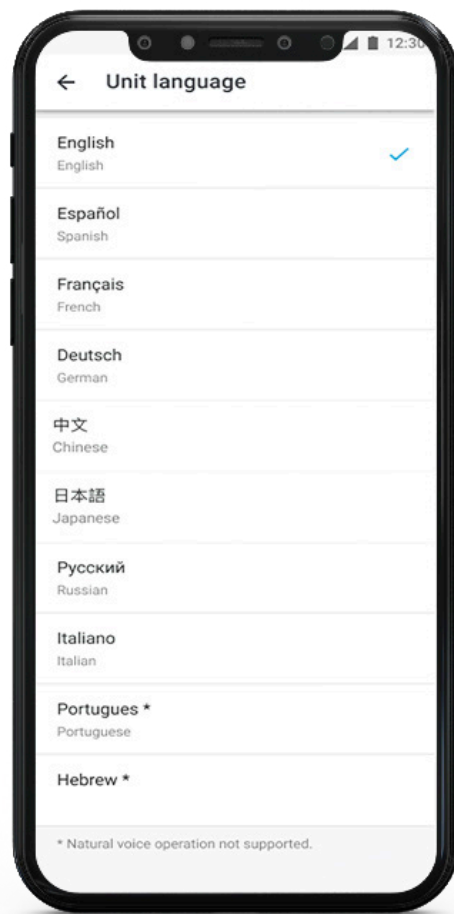

Software Update

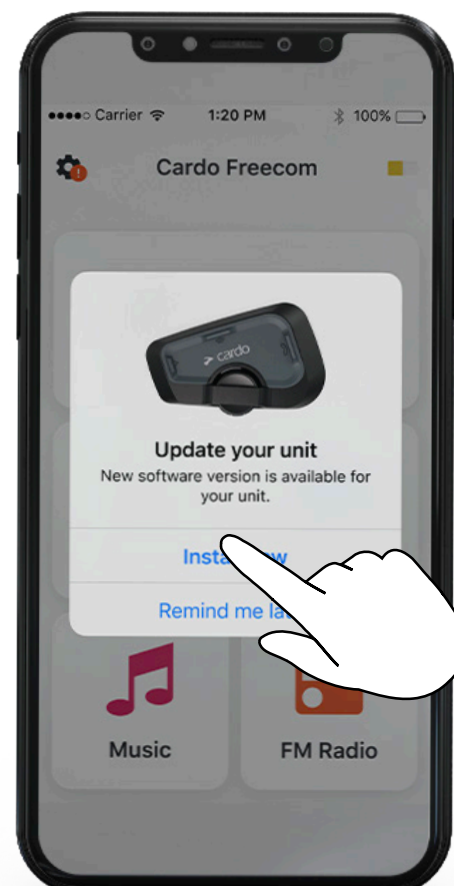

General

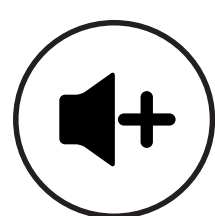

Volume Up

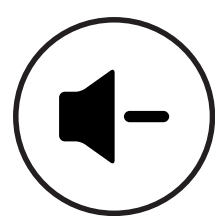
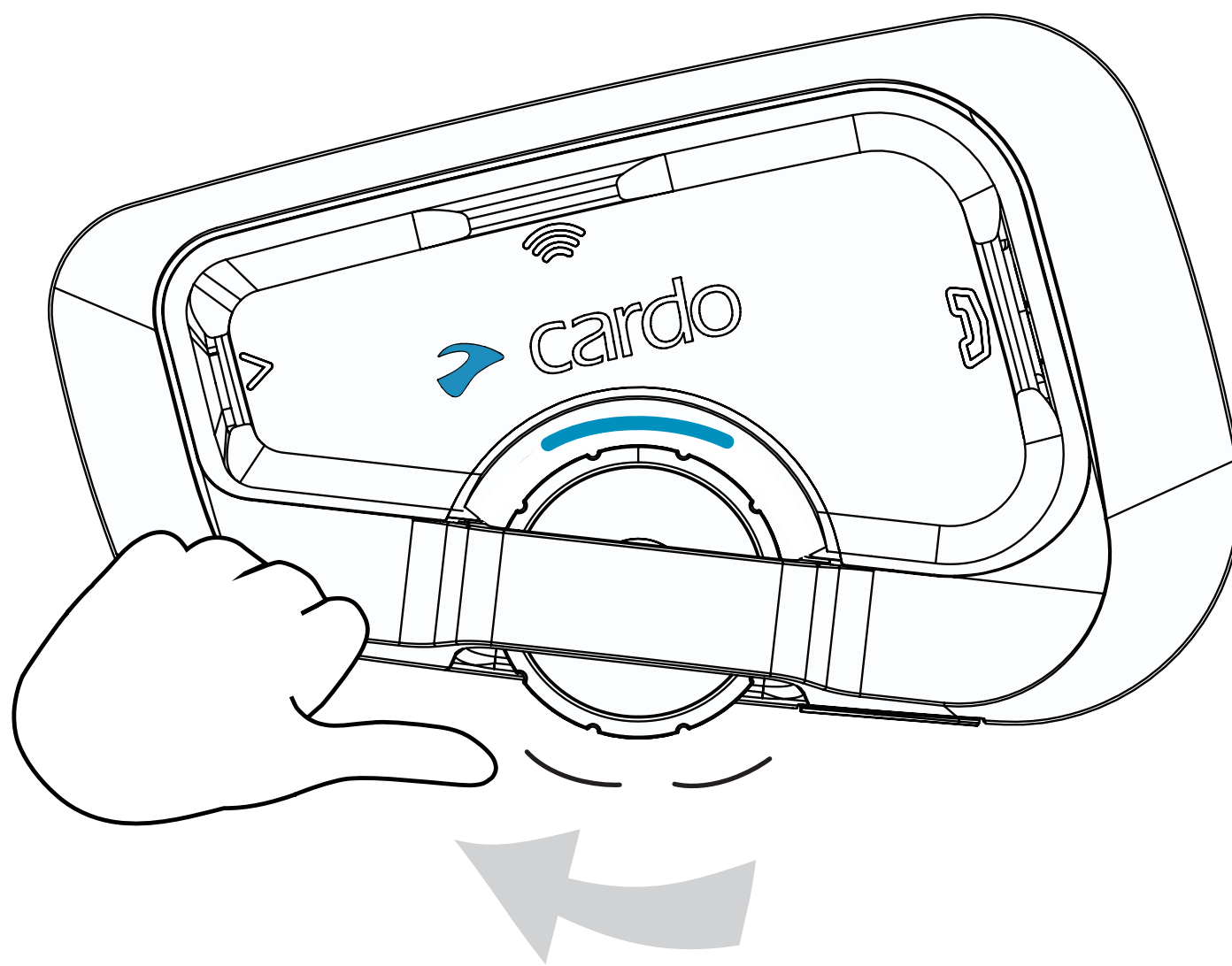

Volume Down

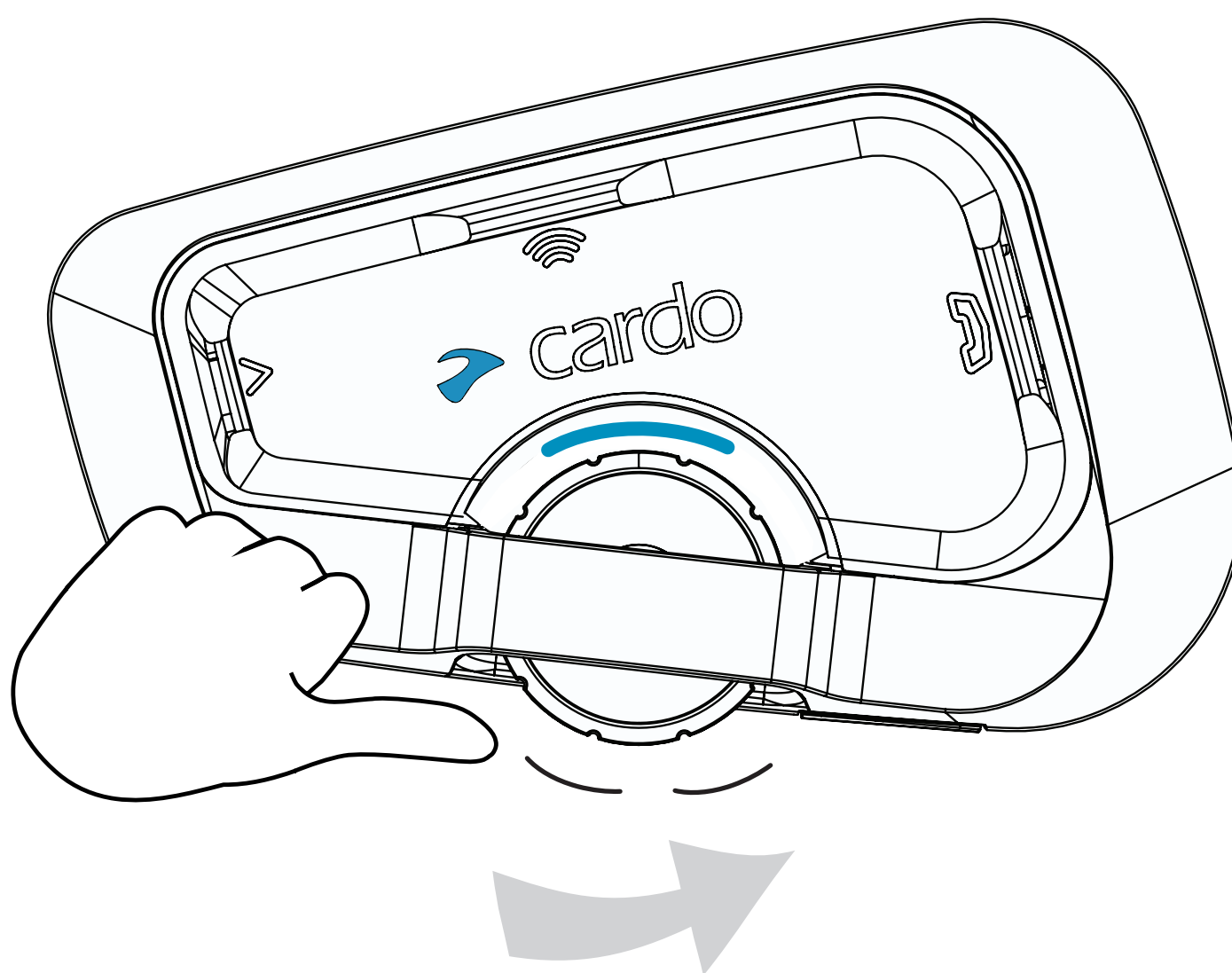

Voice Assistant

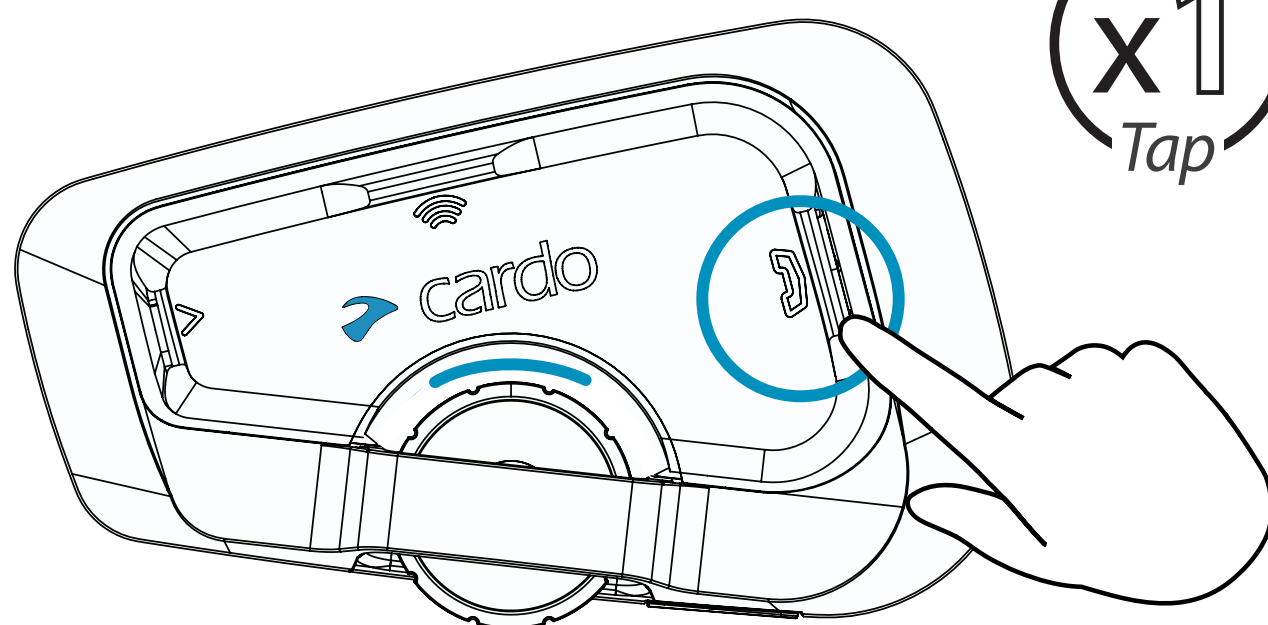

Music

 Play

 x1
Tap

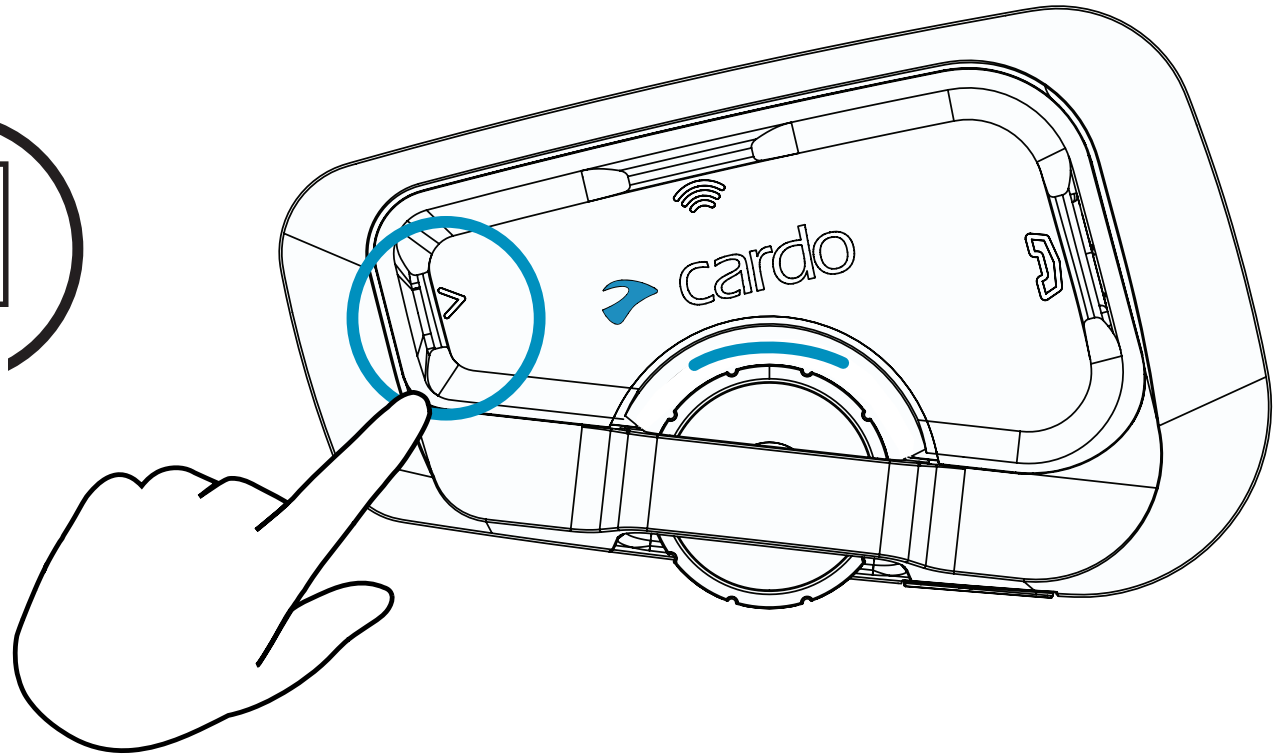

 Pause

 x1
Tap

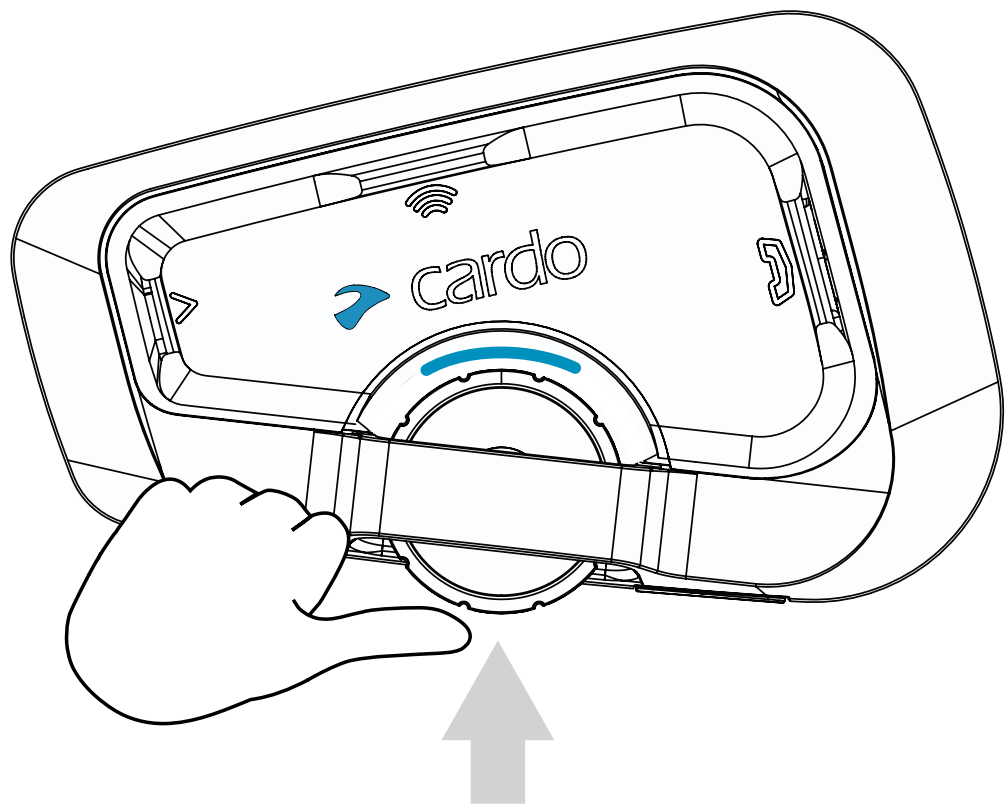

 Next

 x1
Tap

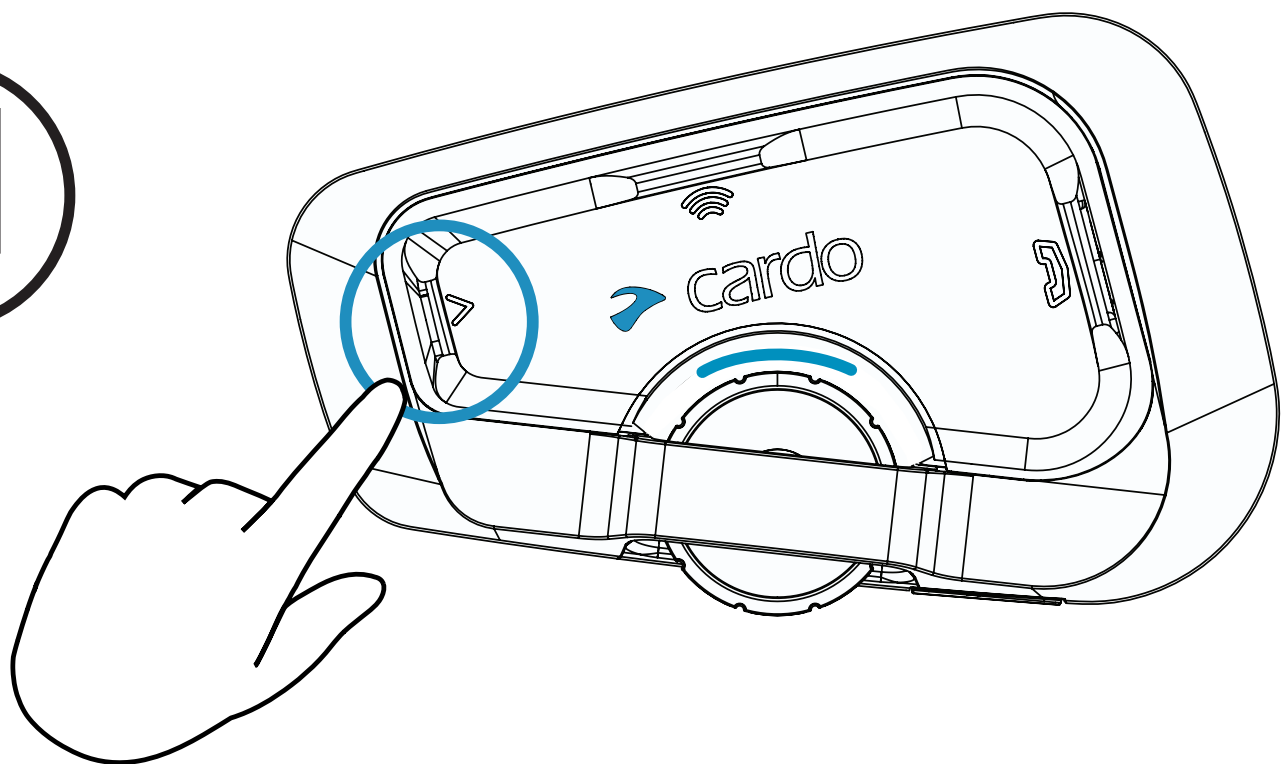

 Previous

 x2
Tap

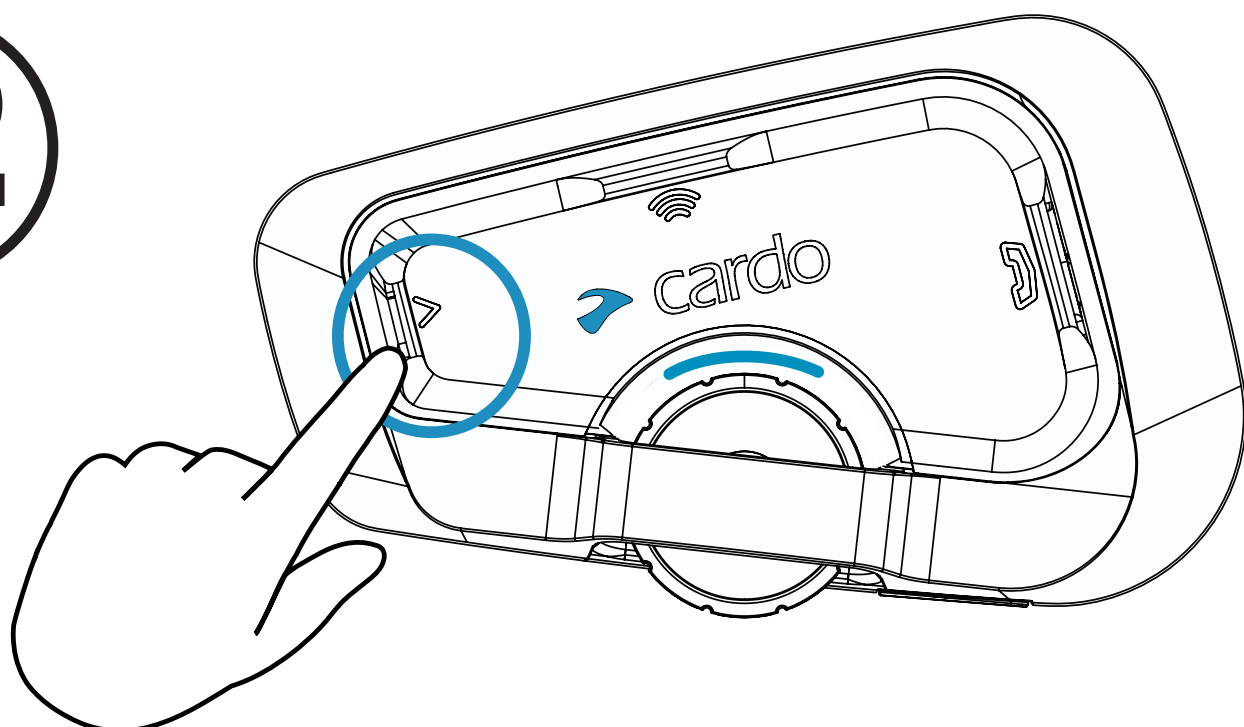

Radio



Set Presets

1

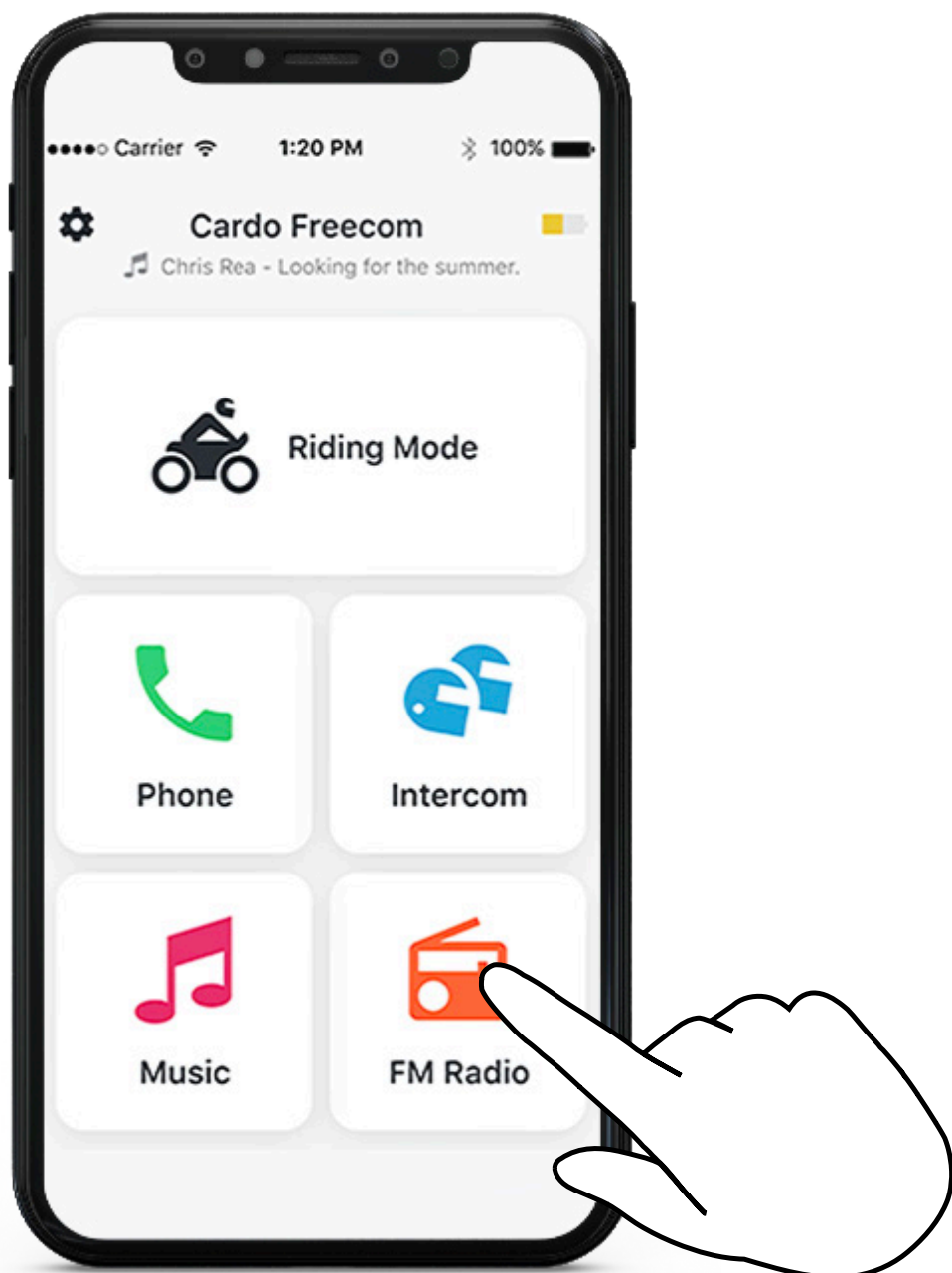

2

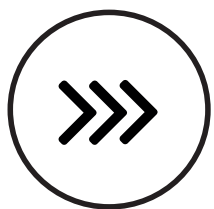
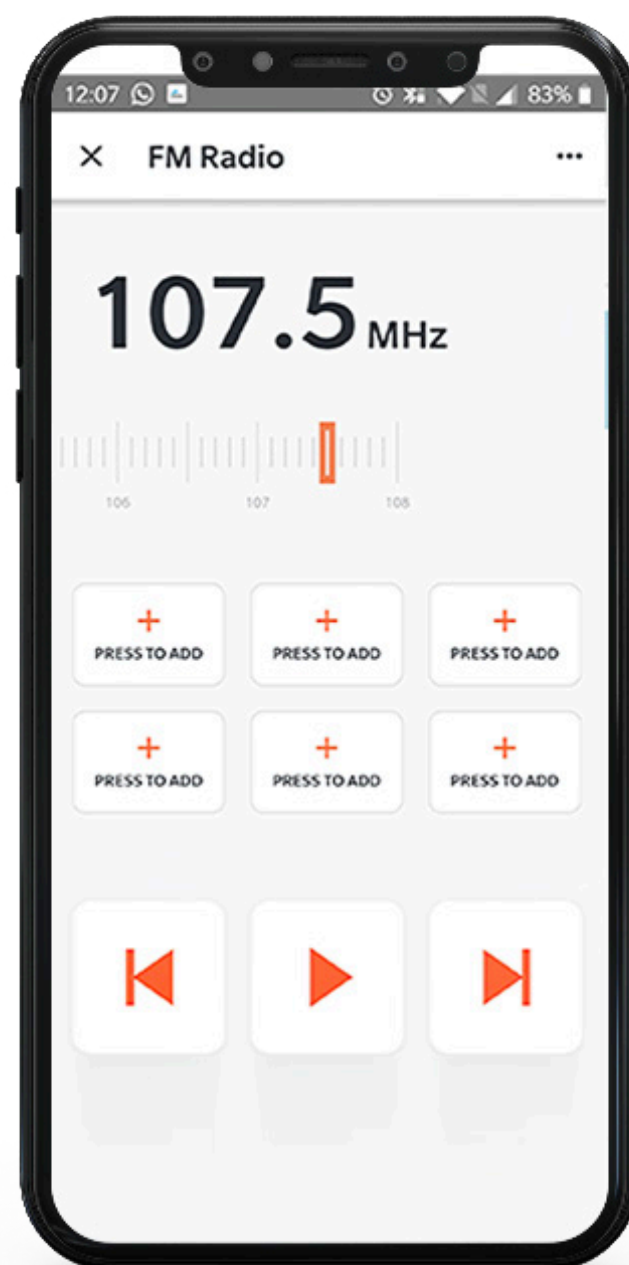

Start Scan

X3
Tap

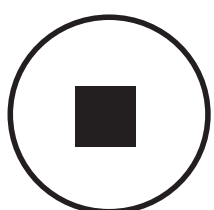
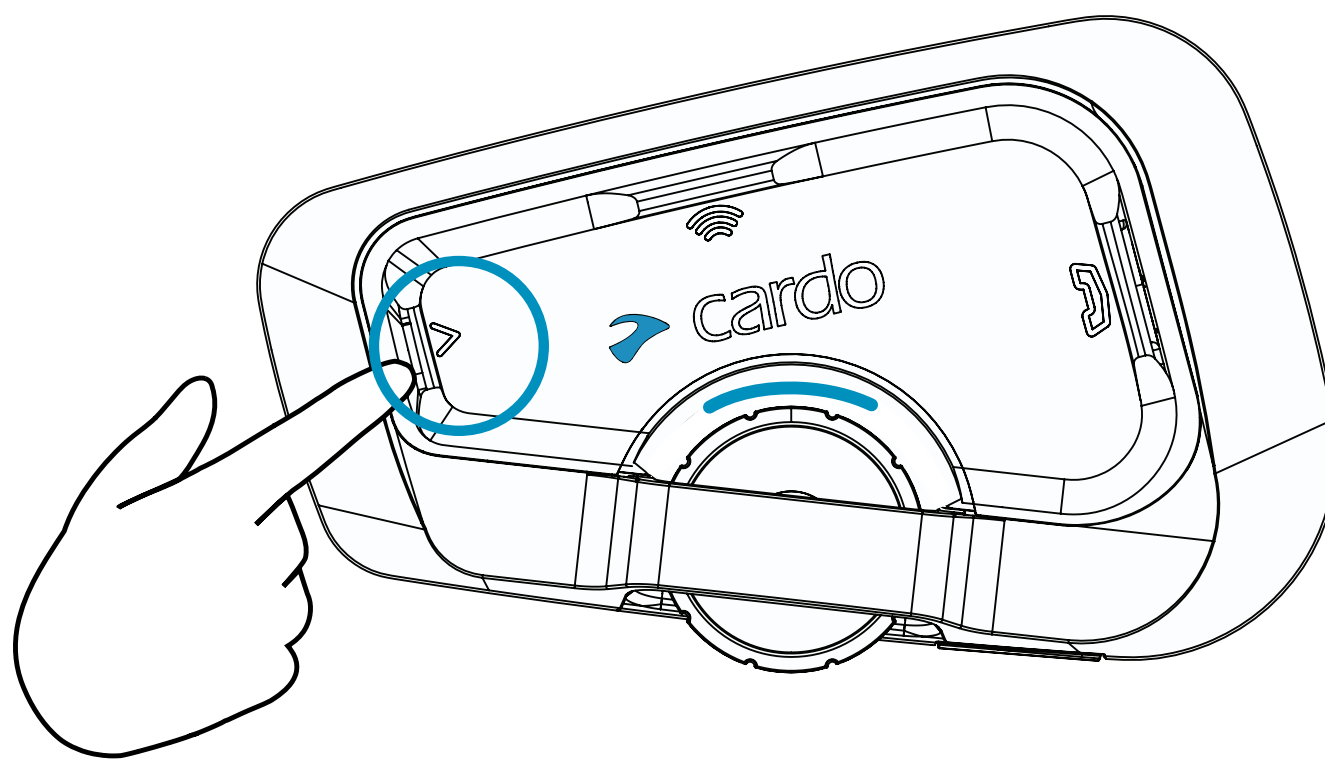

Stop Scan

X1
Tap

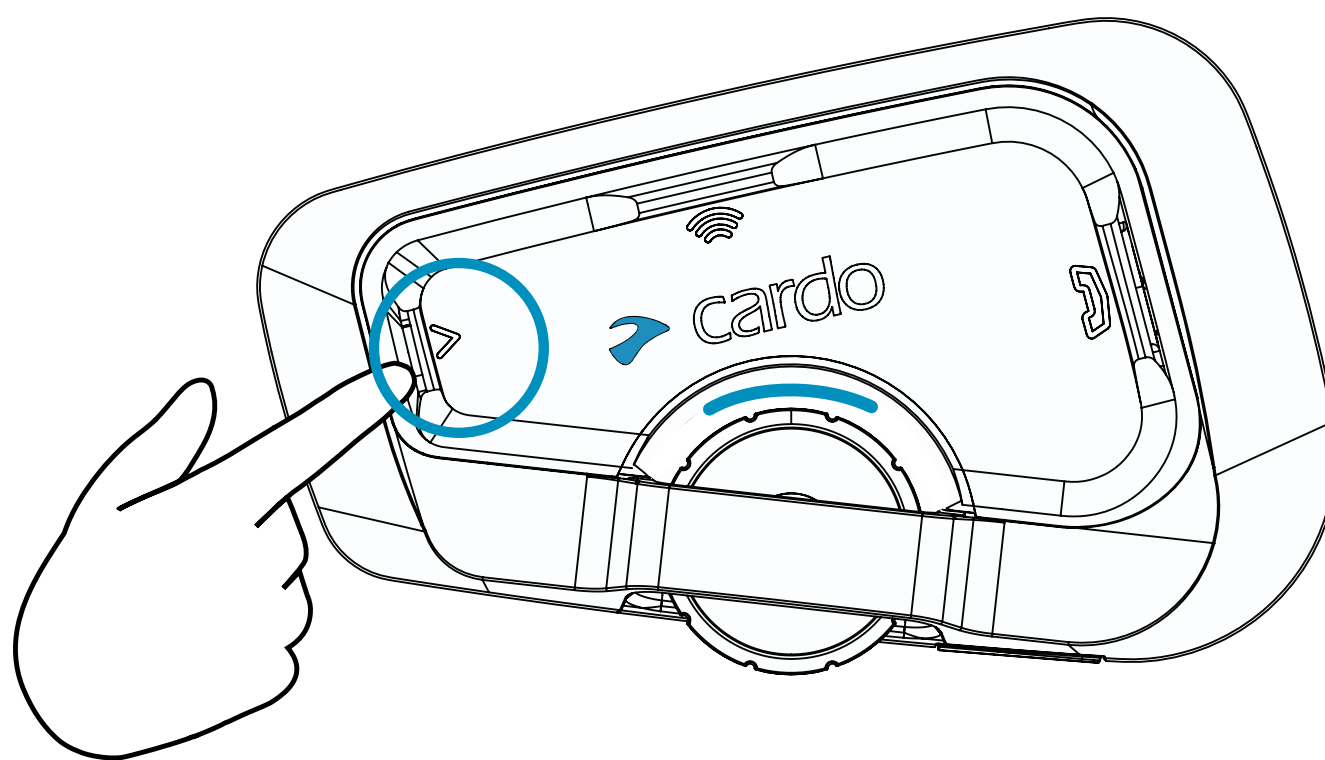

Radio



On

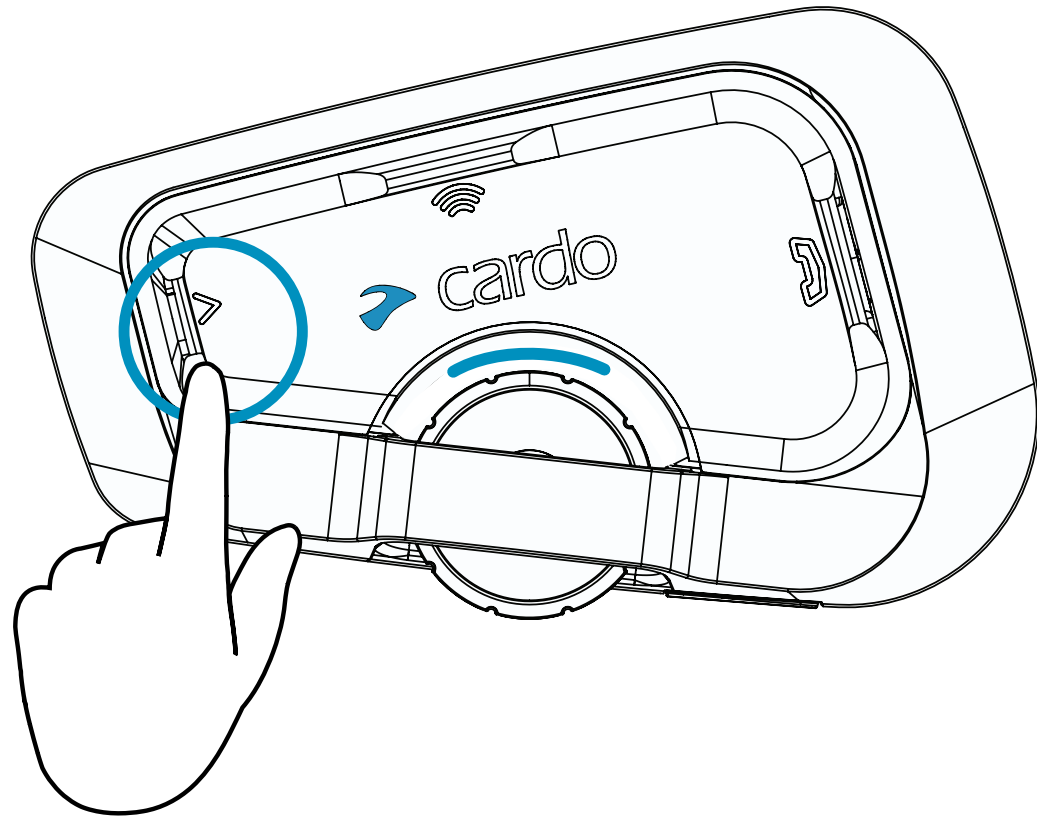

Off

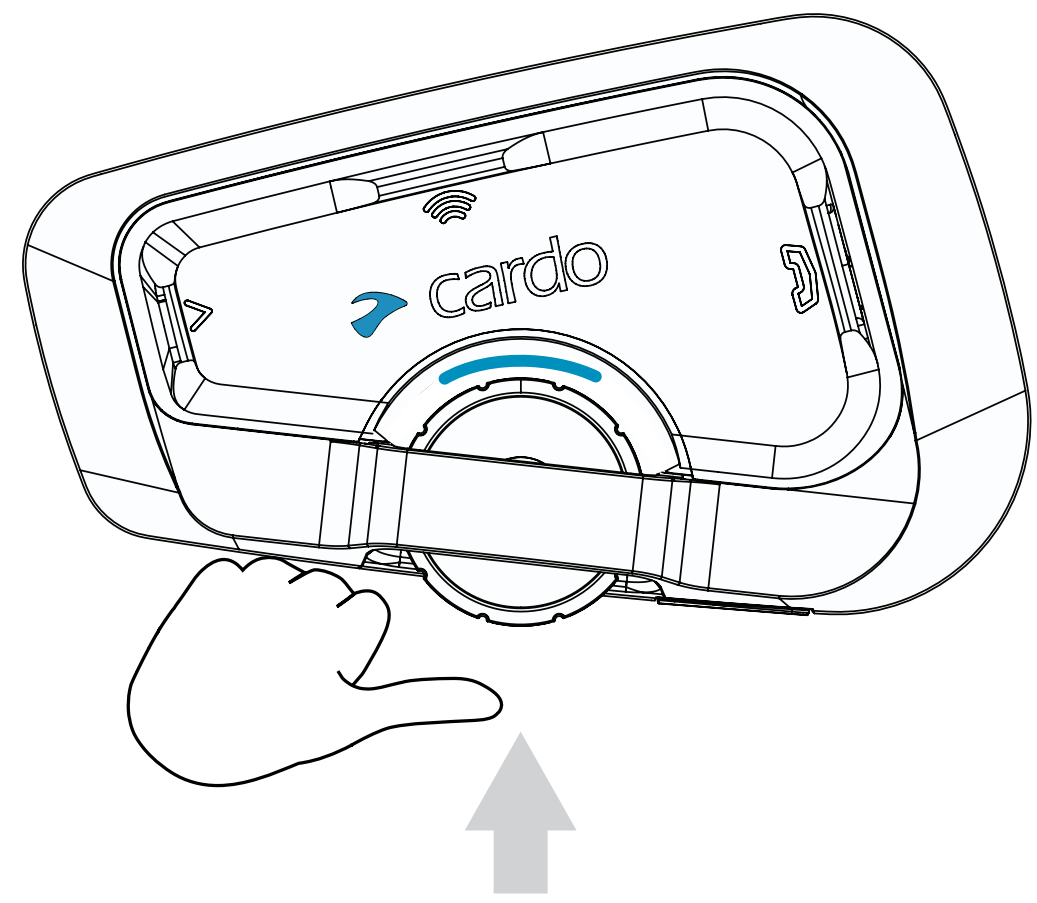

Next Preset

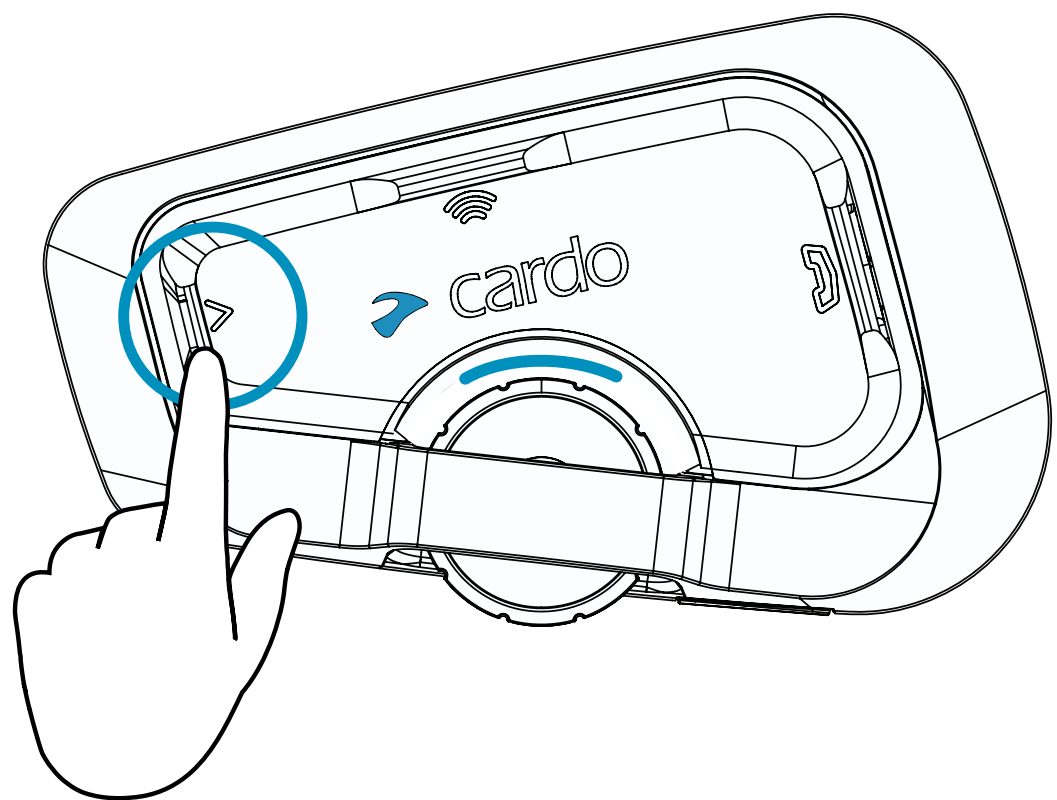

Previous Preset

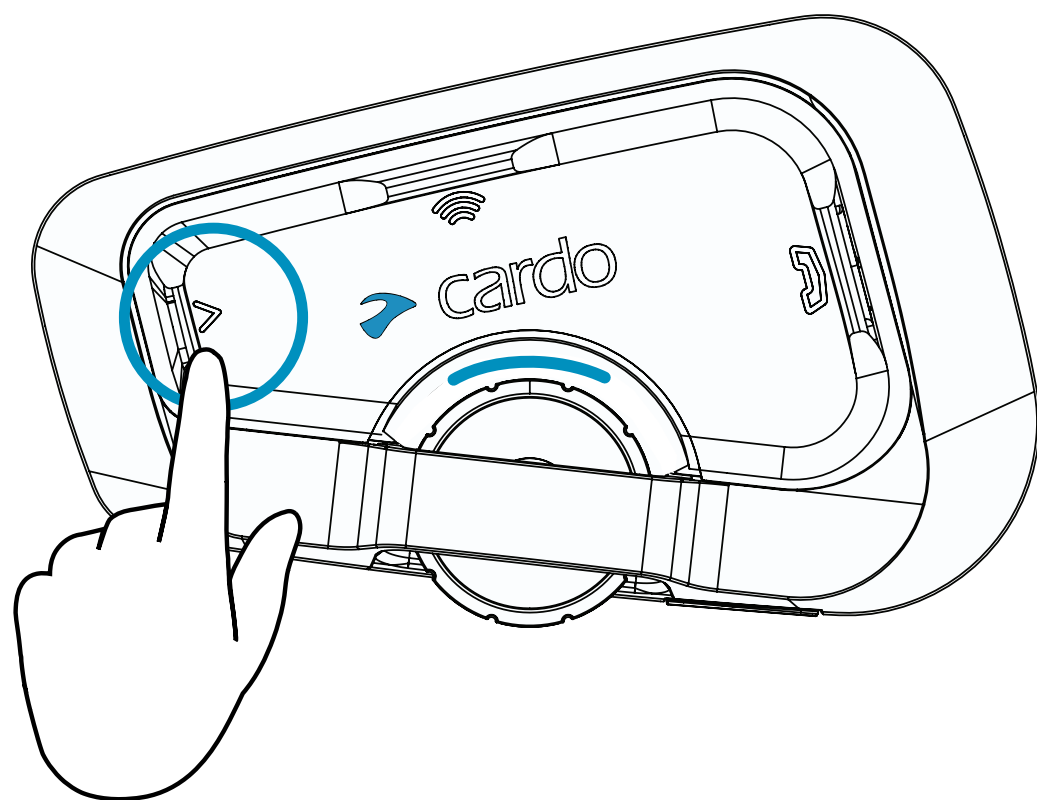

Switch Source



Music to Radio

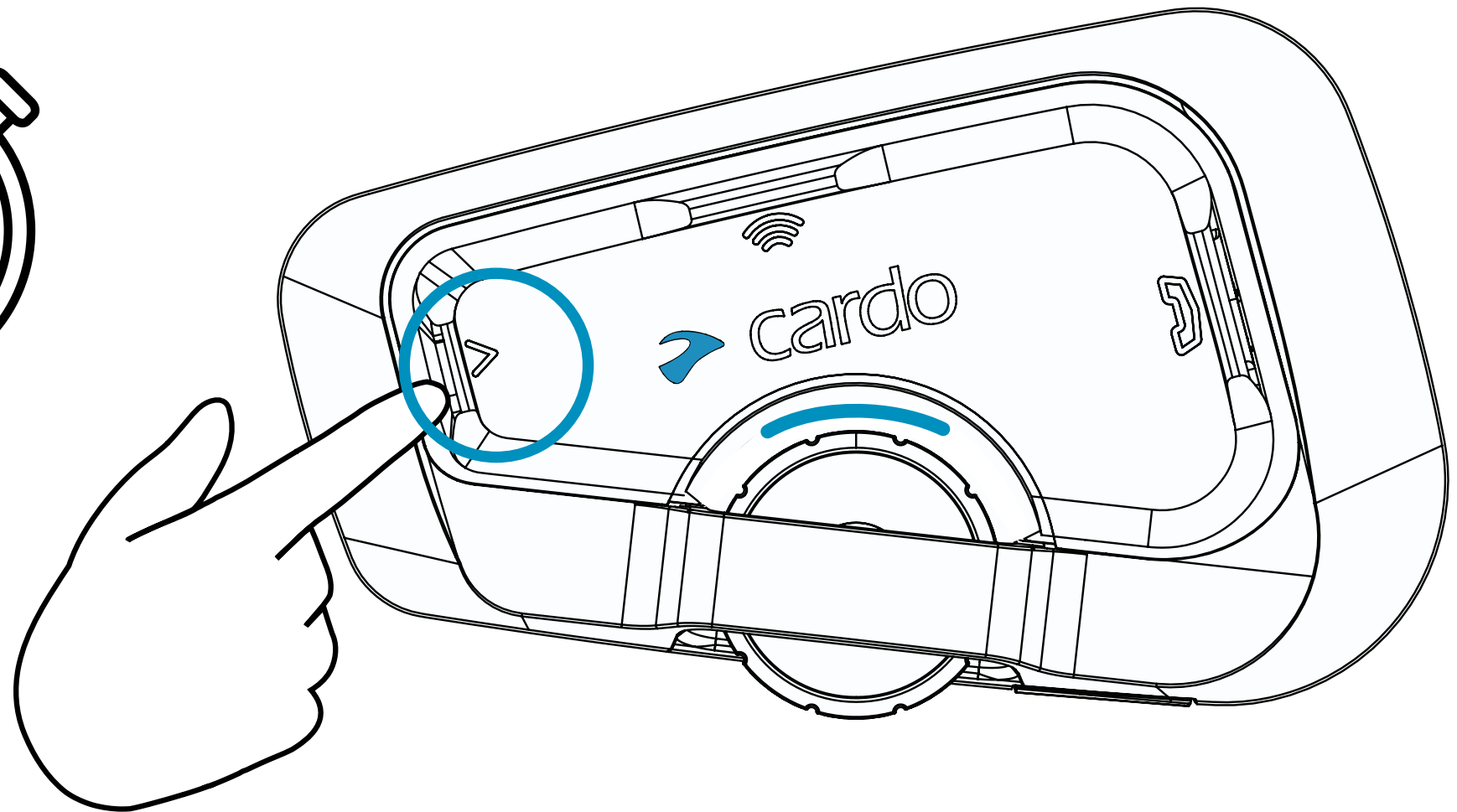

Radio to Music

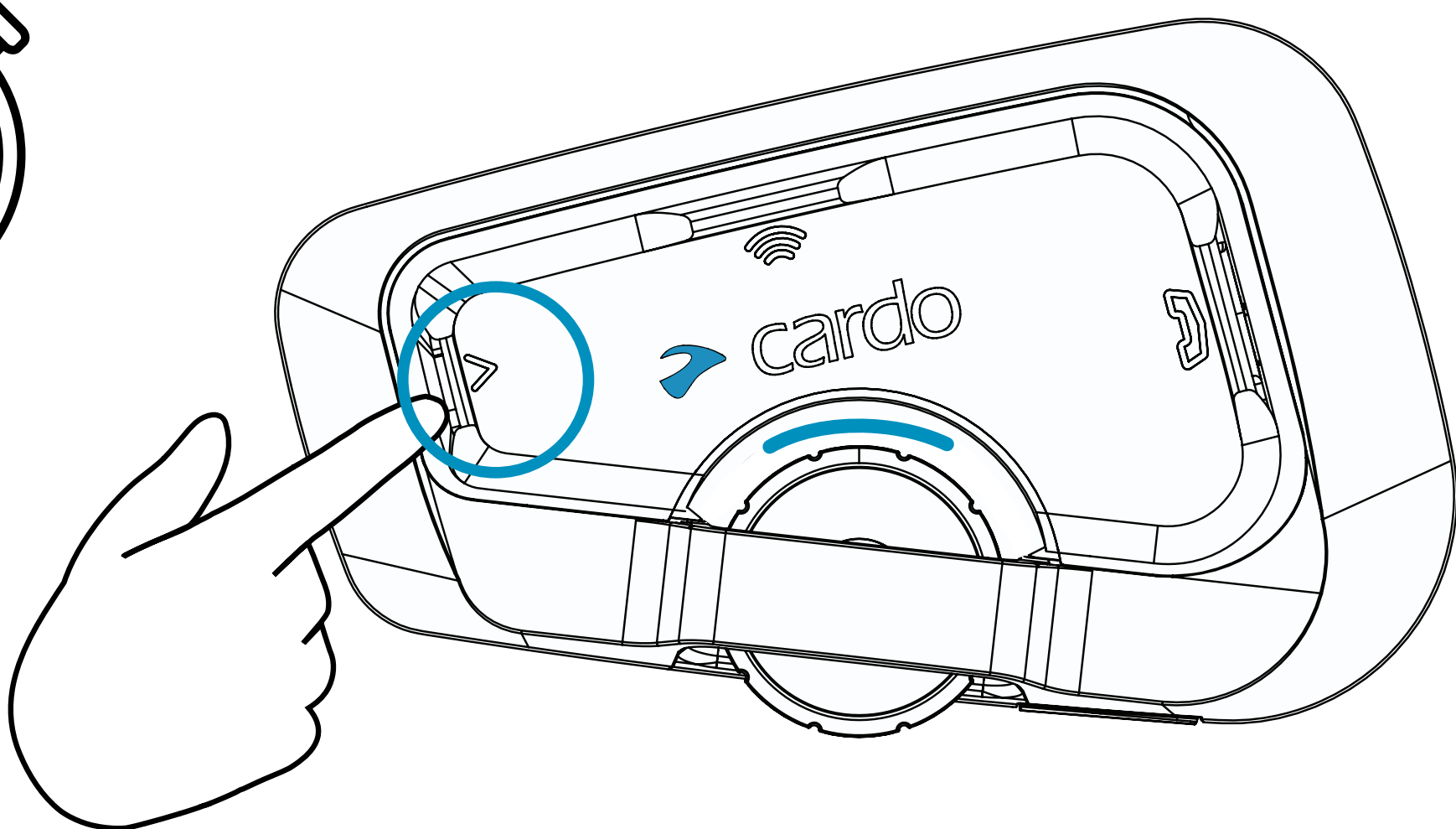
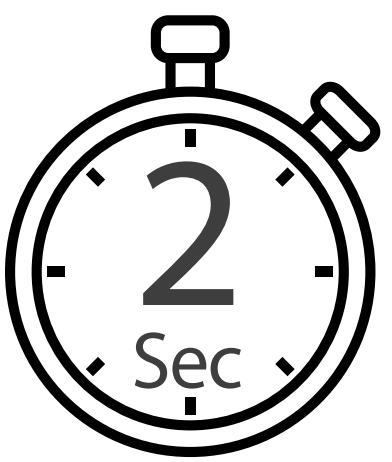

Phone Call



Answer

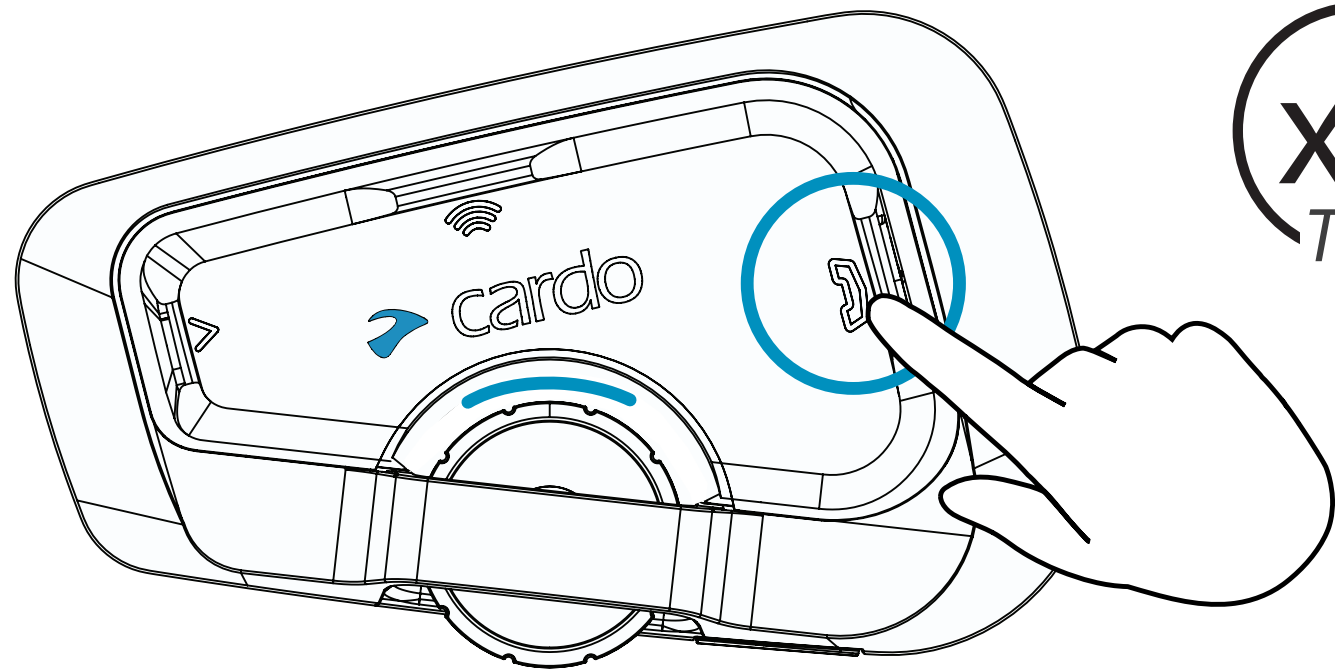

Ignore

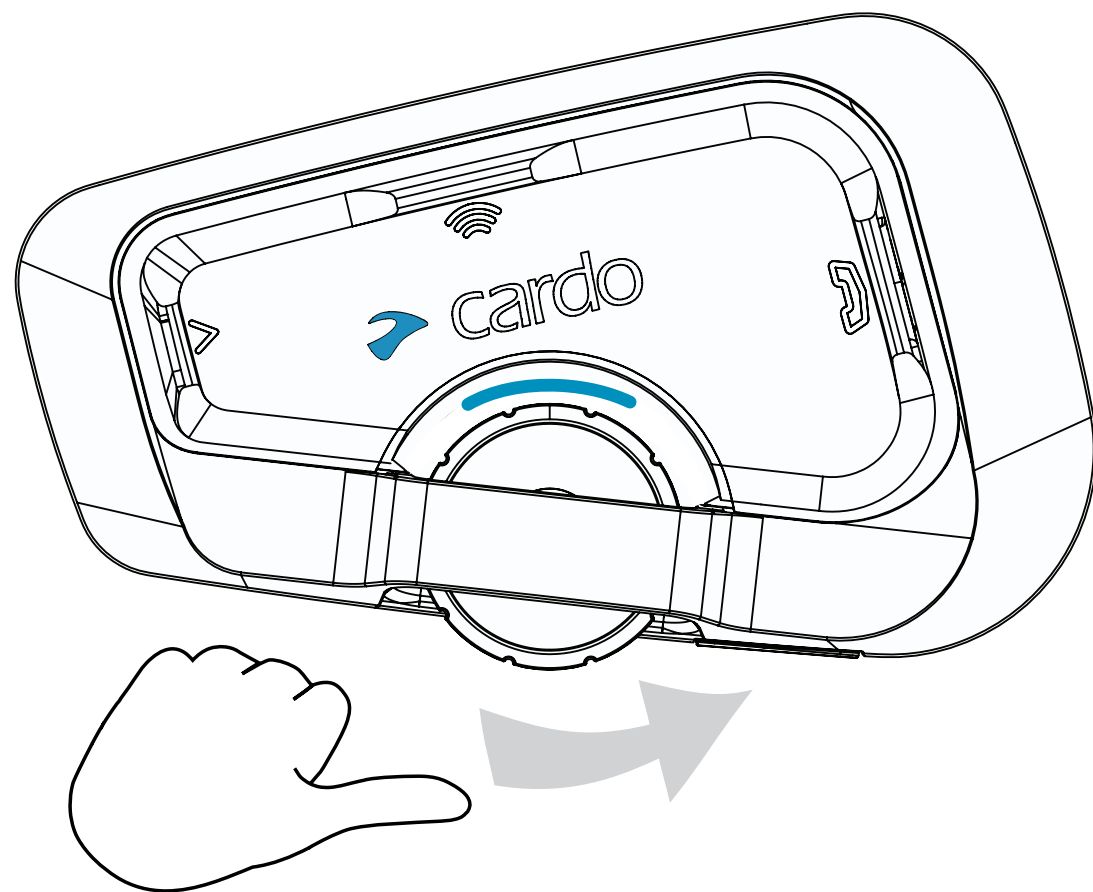

End Call

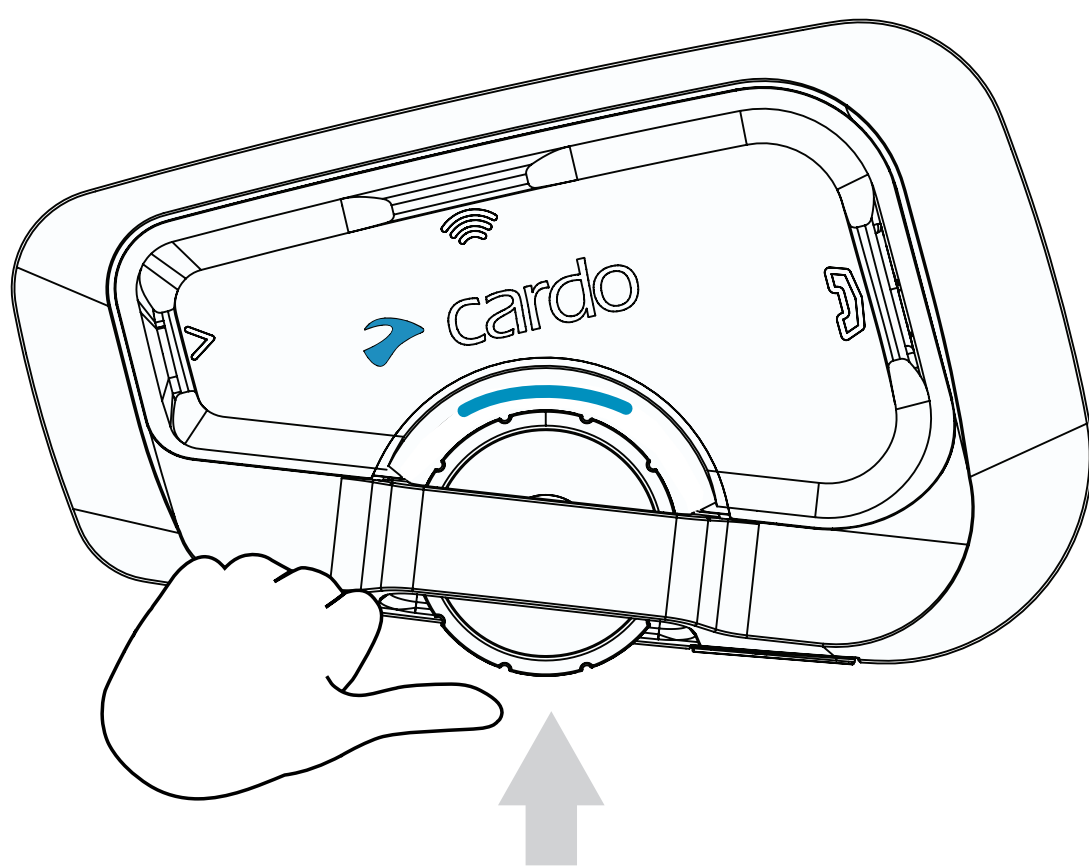

Redial

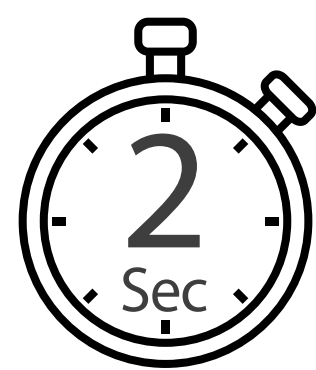
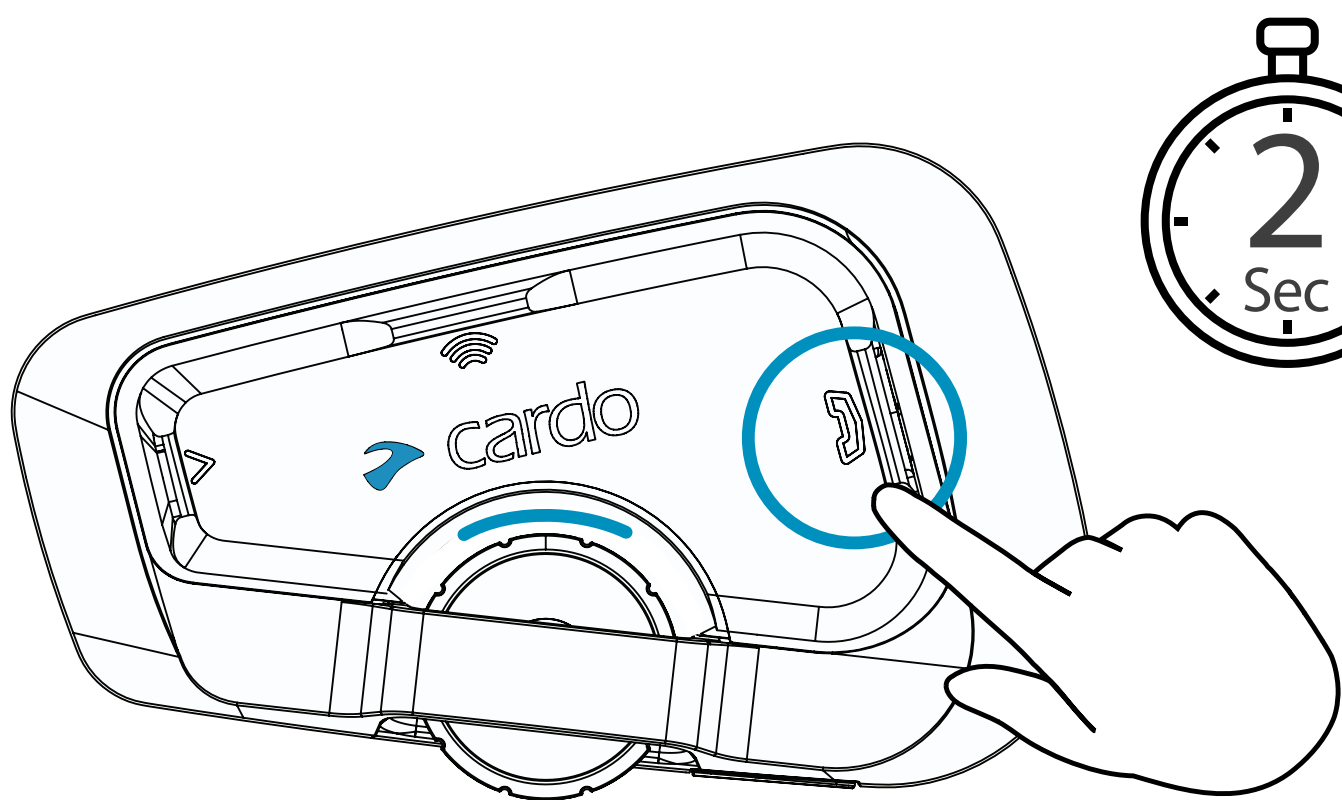

Phone Call



Speed Dial

Set Number

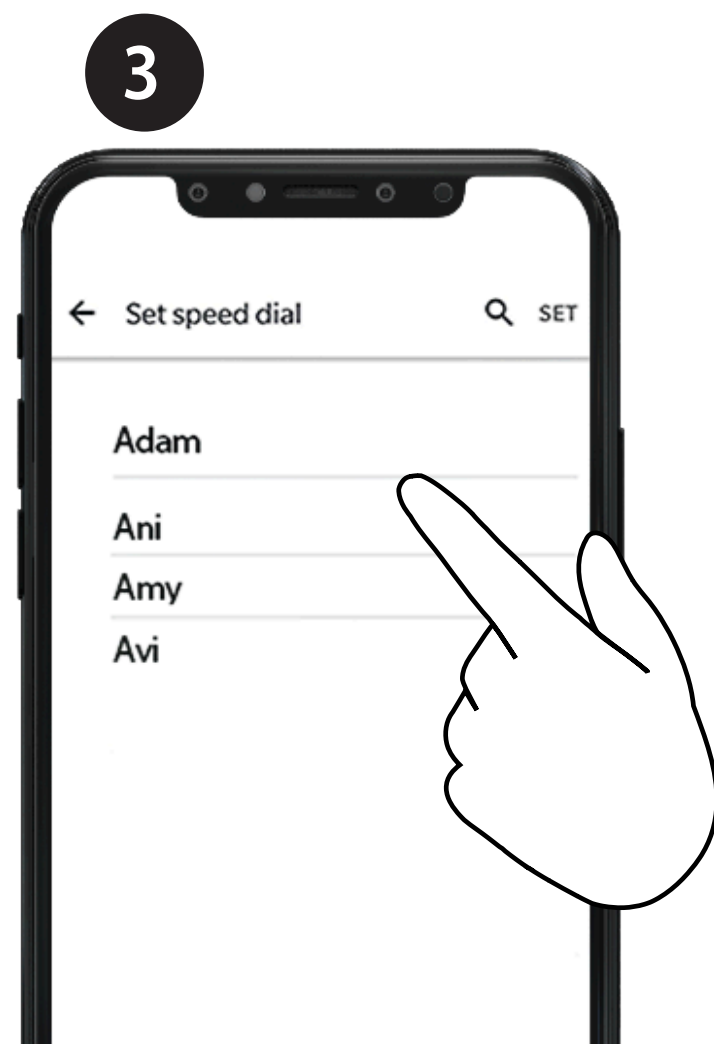
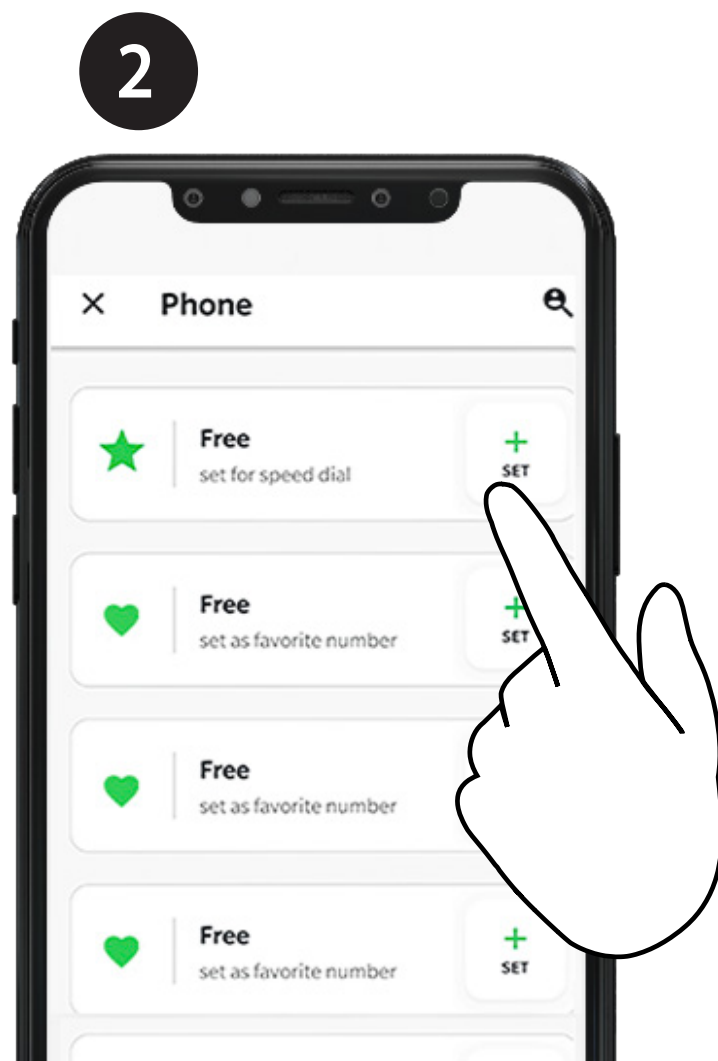
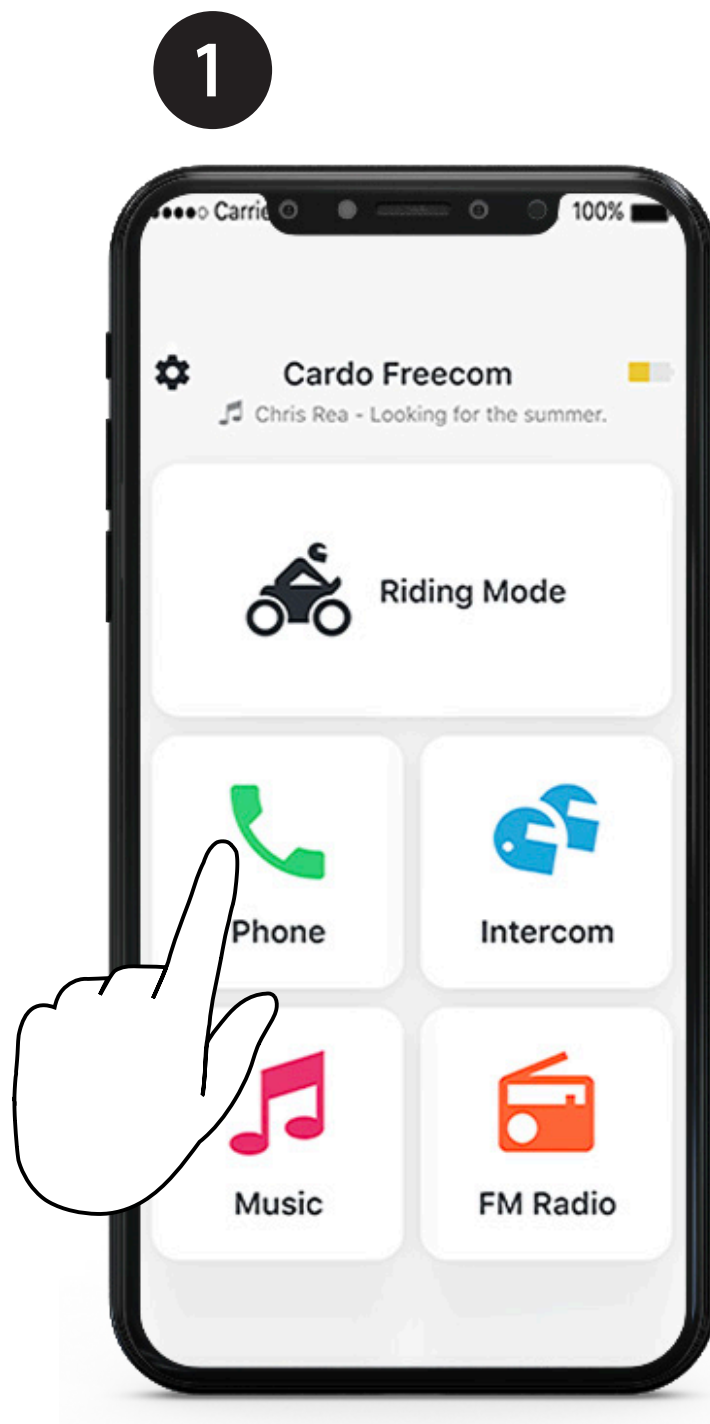

Call Speed Dial

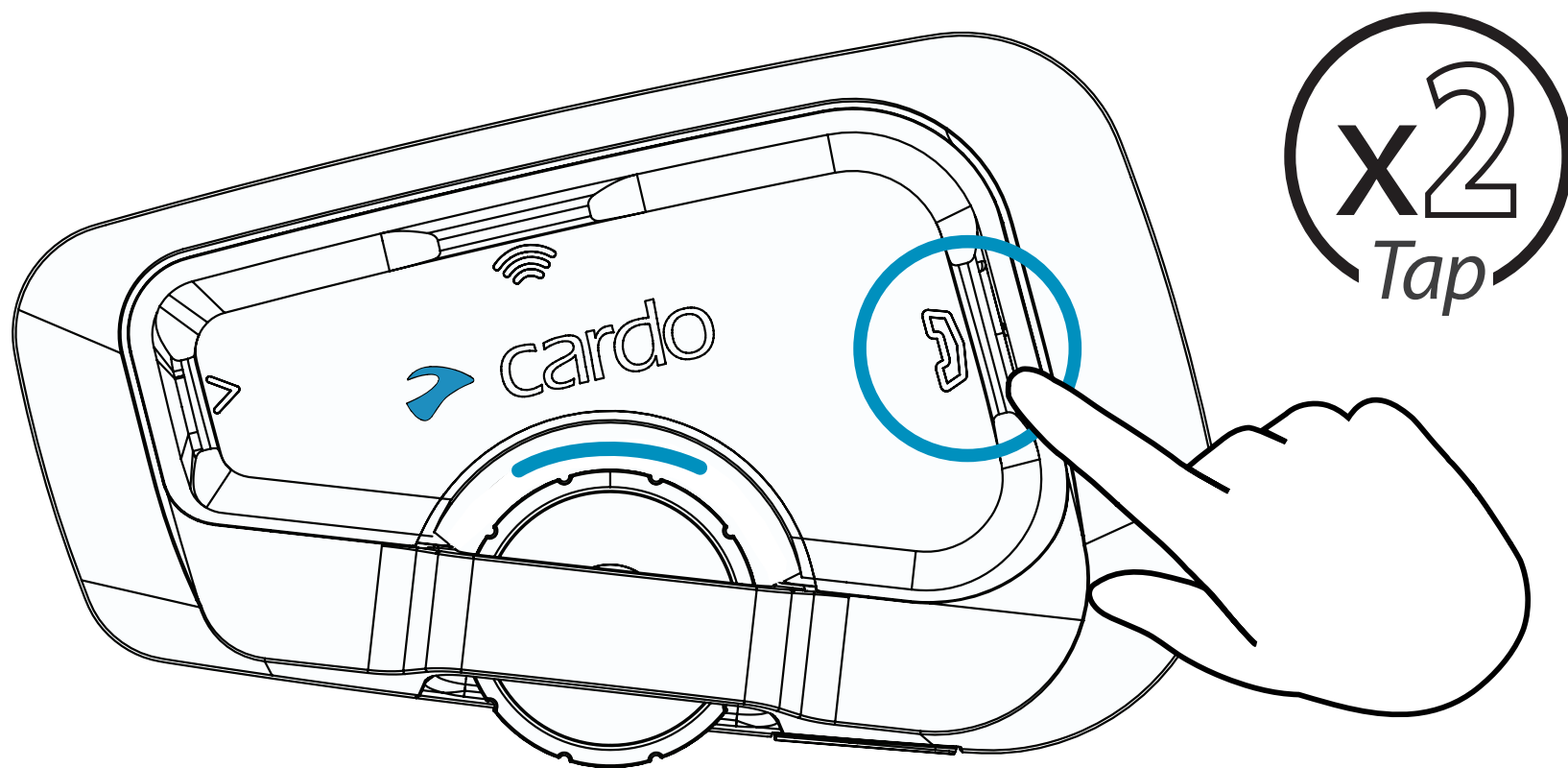

Bluetooth Intercom



Pairing

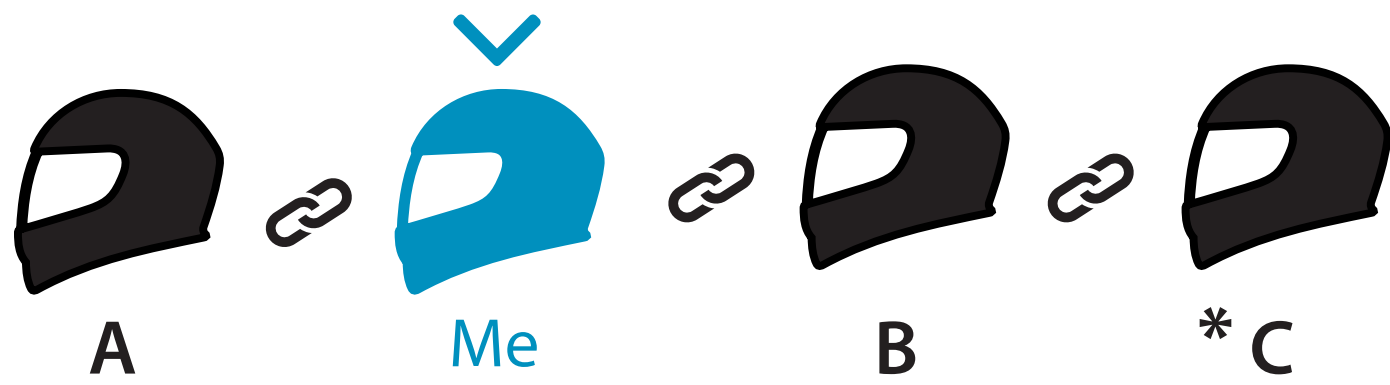

Pair to Rider A

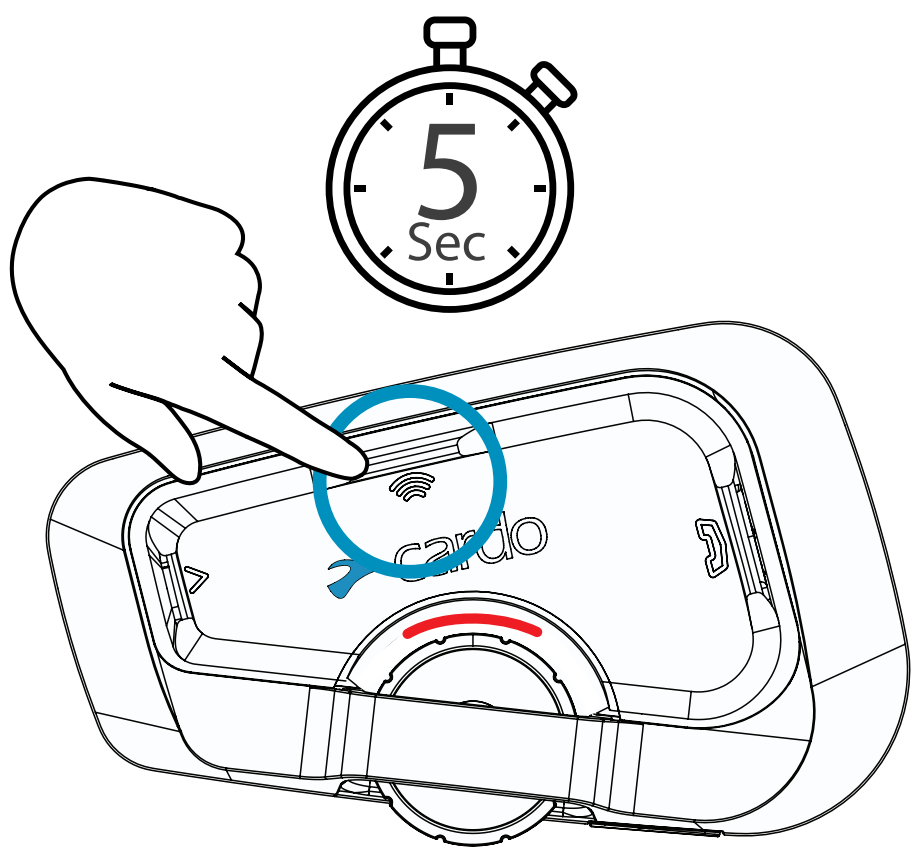

Pair to Rider B

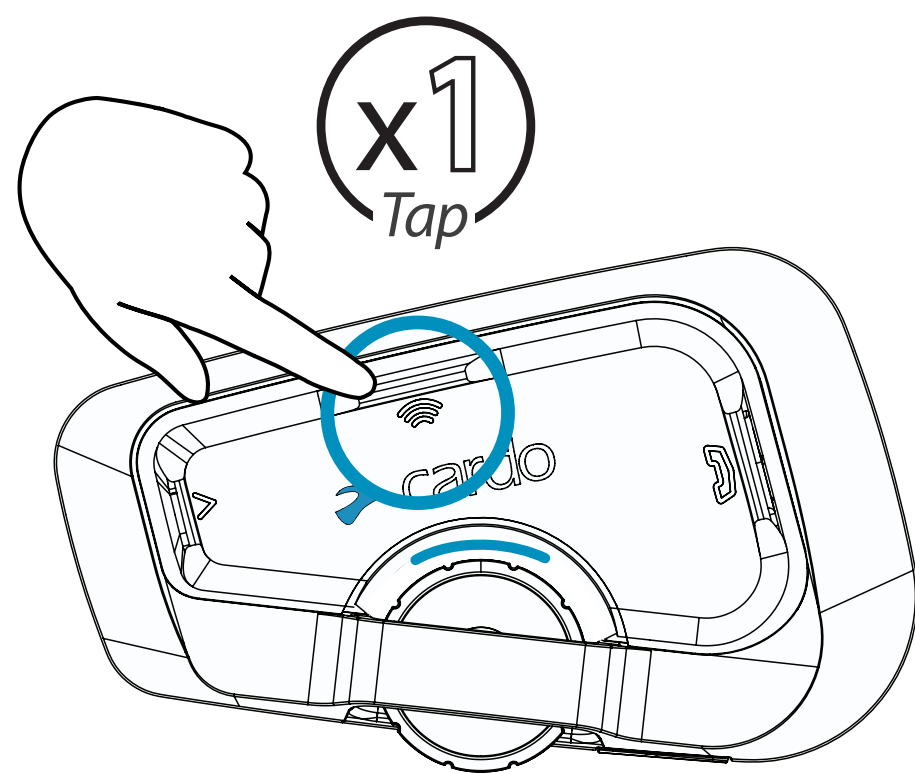
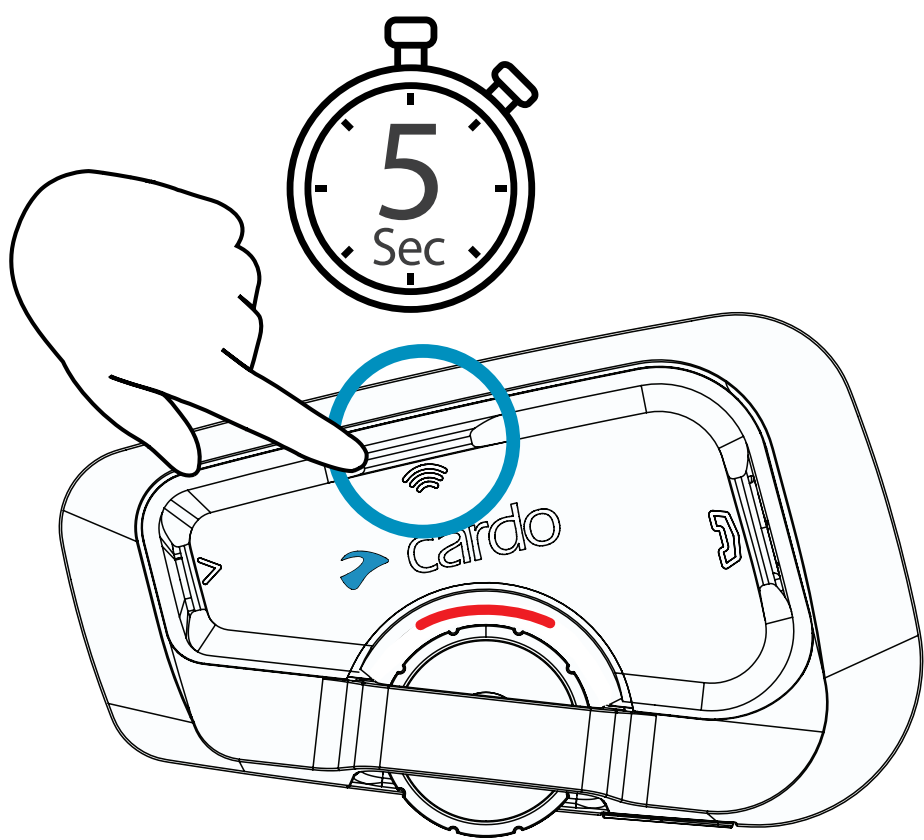

* Rider C should be connected to Rider B

Bluetooth Intercom



Call / End Intercom

Rider A

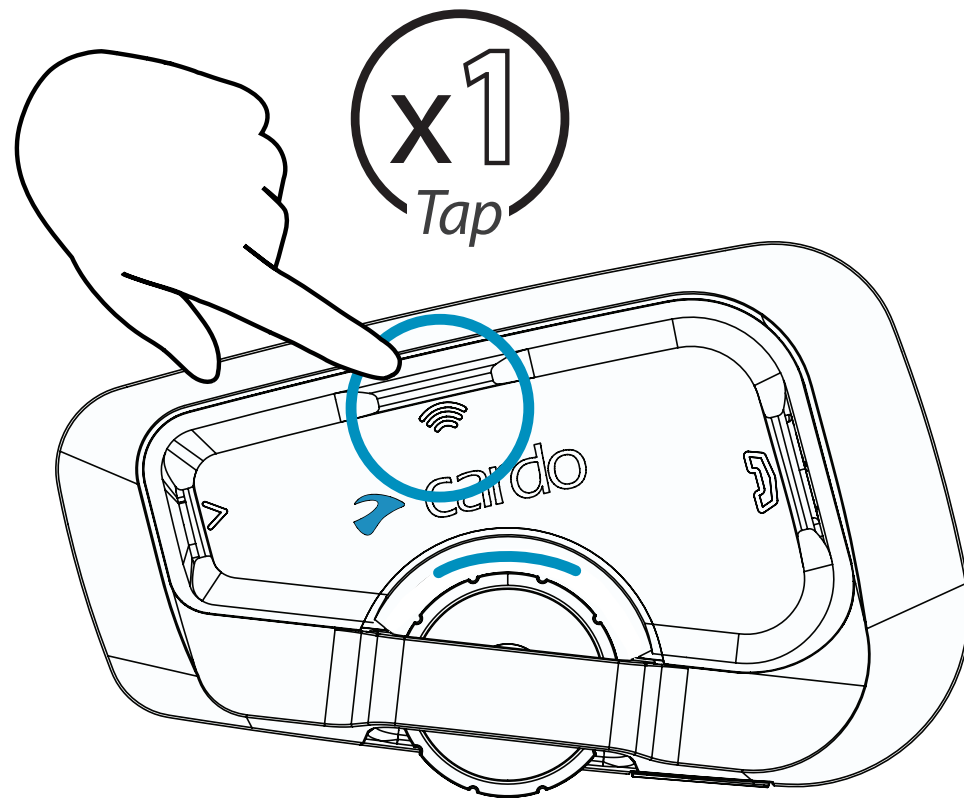

Rider B

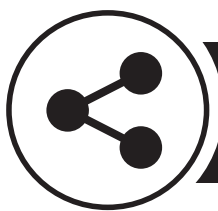
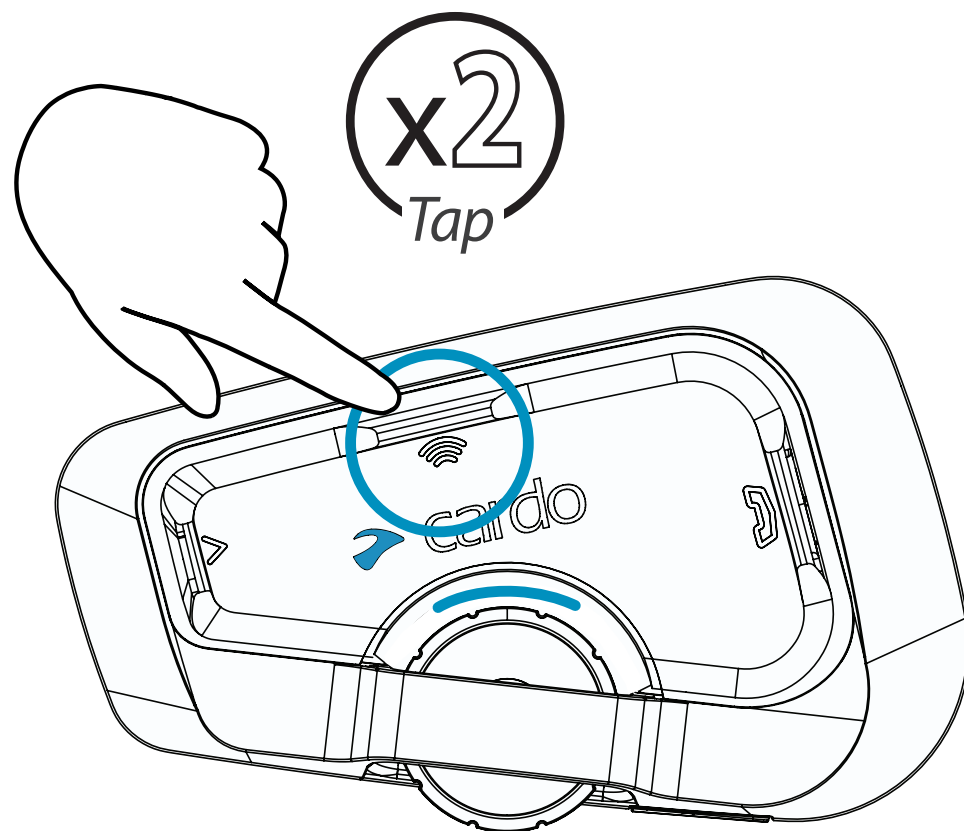

Share



Share Music

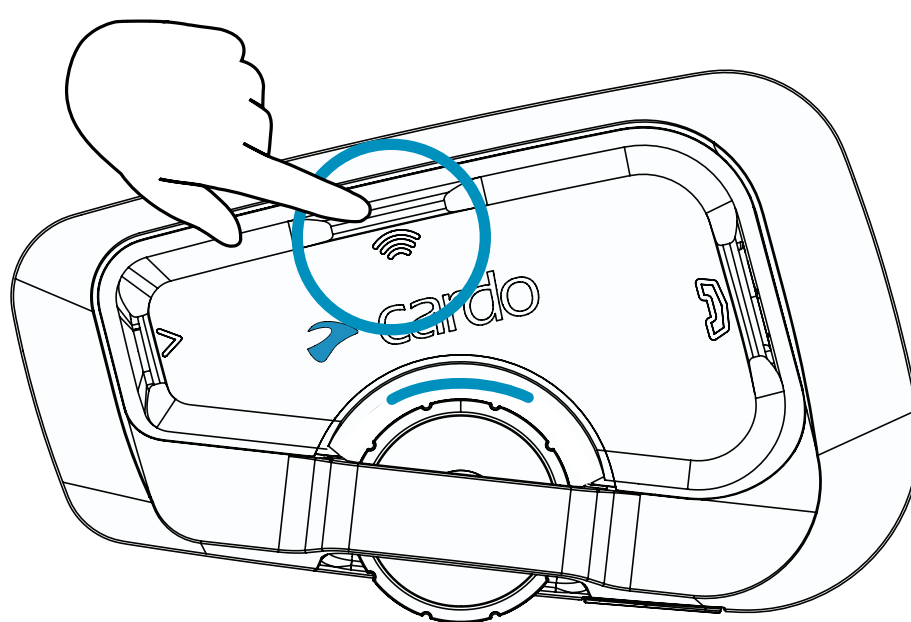

Share Phone Call

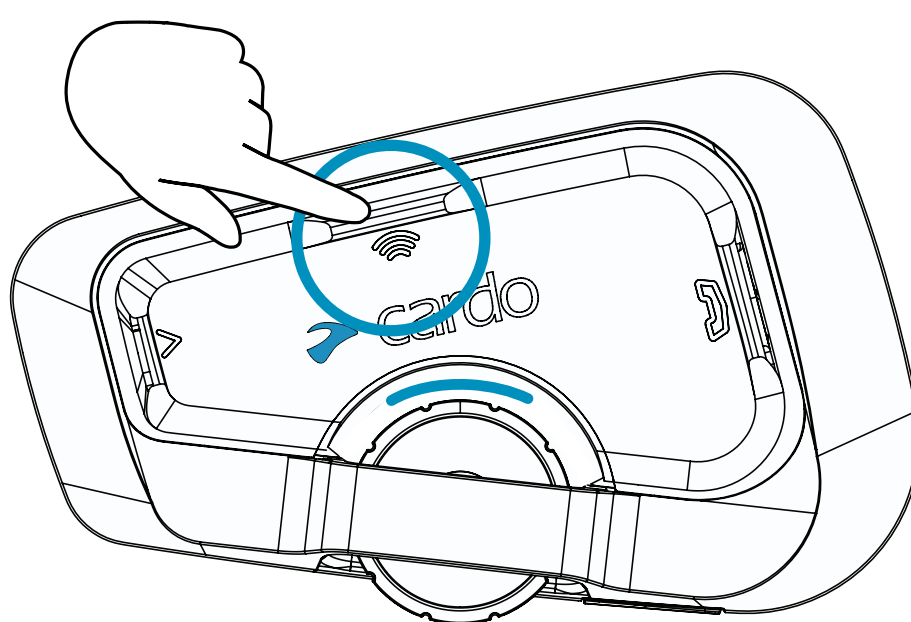
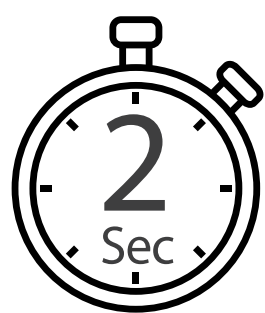

GPS Pairing

1 Step 1

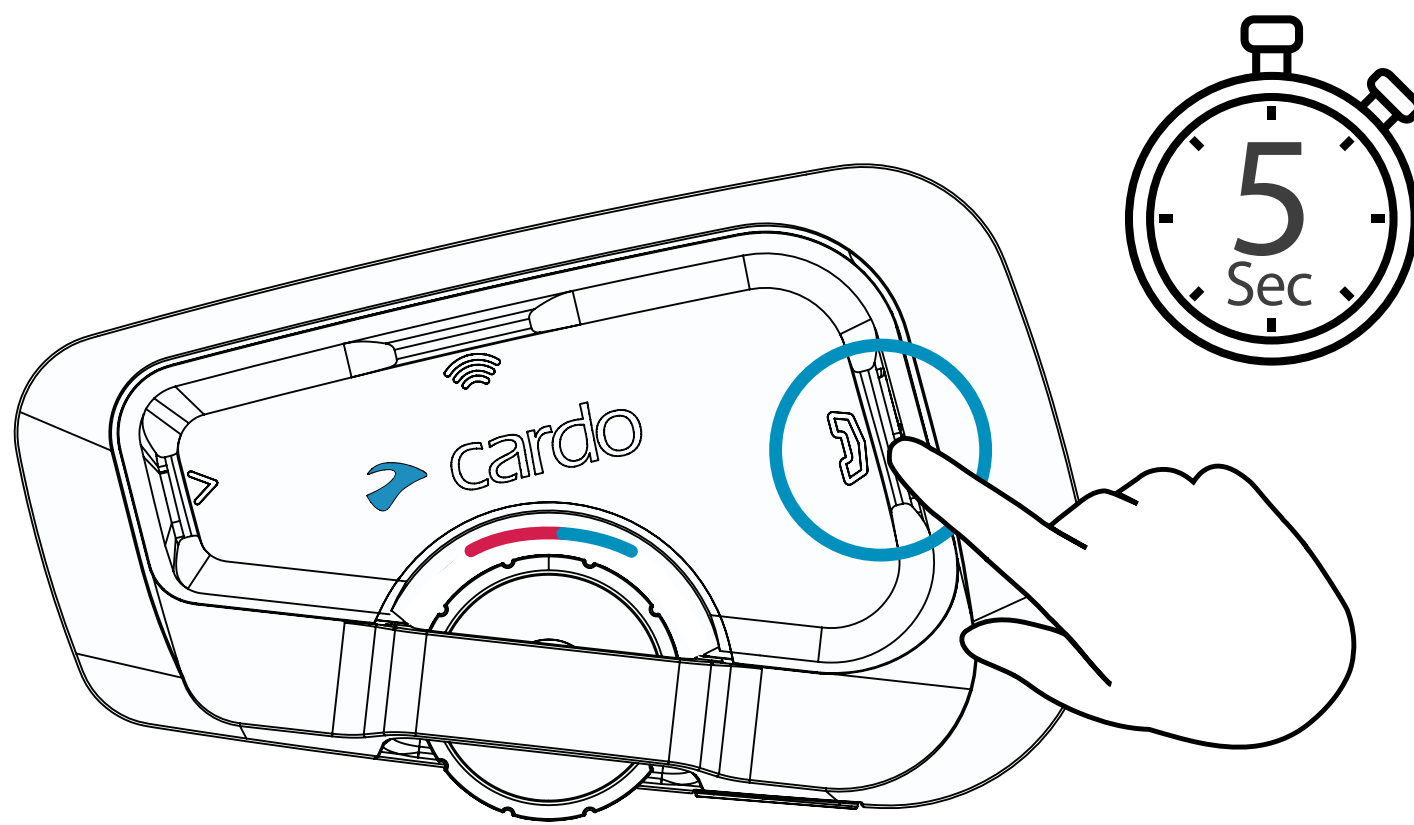

LED Red & Blue



2 Step 2

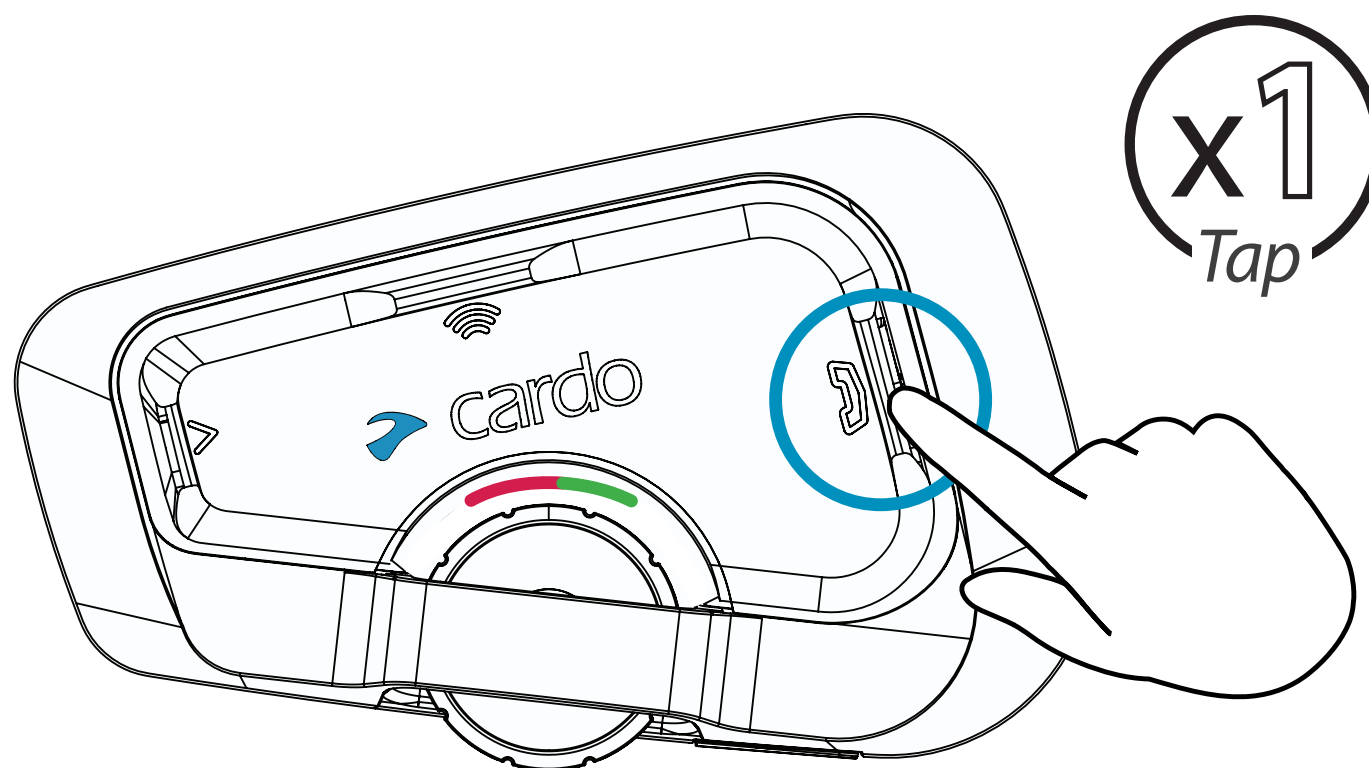

LED Red & Green



3 Step 3



Voice Commands - Always On!



- **Answer**
- **Ignore**
- "Hey Cardo, **end call**"
- "Hey Cardo, **speed dial**"
- "Hey Cardo, **redial number**"



- "Hey Cardo, **music on**"
- "Hey Cardo, **music off**"
- "Hey Cardo, **next track**"
- "Hey Cardo, **previous track**"
- "Hey Cardo, **share music**"



- "Hey Cardo, **radio on**"
- "Hey Cardo, **radio off**"
- "Hey Cardo, **next station**"
- "Hey Cardo, **previous station**"



- "Hey Cardo, **call intercom**"
- "Hey Cardo, **end intercom**"



- **"Hey Siri"**
- **"OK Google"**



- "Hey Cardo, **volume up**"
- "Hey Cardo, **volume down**"
- "Hey Cardo, **mute audio**"
- "Hey Cardo, **unmute audio**"

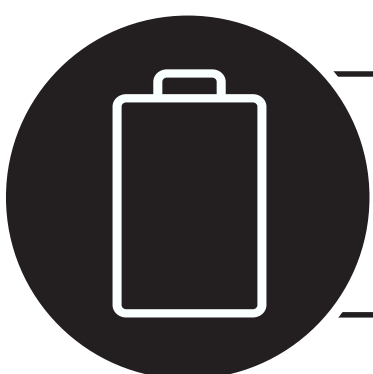

- "Hey Cardo, **battery status**"

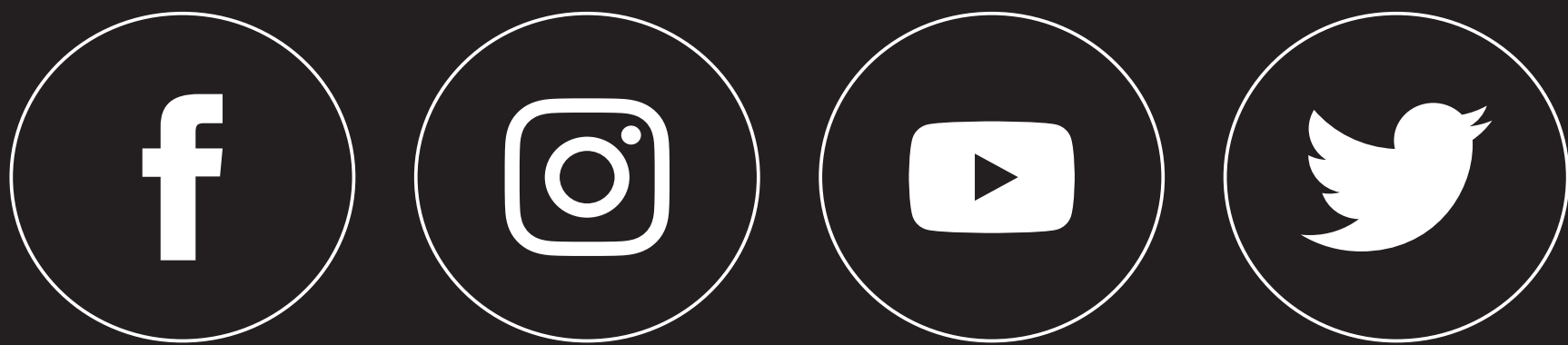

Cardosystems.com

Cardosystems.com/update

Cardosystems.com/support